



architectural lighting

**PUNKT**  
LINIE  
FLÄCHE

POINT LINE PLANE

POINT LIGNE PLAN

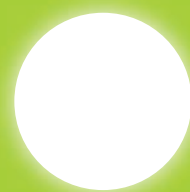



**D** Die optimale Nutzung des Lichts – ob natürlich oder künstlich – ist eines der Hauptziele von durlum.

Als Hersteller von Metalldecken, Licht- und Tageslichtsystemen forschen und entwickeln wir zusammen mit namhaften Instituten und Universitäten auf diesem Gebiet.

PUNKT LINIE FLÄCHE ist die Konsequenz unserer Entwicklungen im Bereich Licht. Das Konzept befasst sich mit der architektonischen Wirkung von Leuchten im Raum.

Primär geht es uns neben hervorragender Lichtqualität darum, gemeinsam mit unseren Partnern die richtige Lichtgeometrie für die geplante Anwendung zu finden. Sind die Anforderungen definiert, stehen nun die in Frage kommenden Leuchten zur Wahl – eine einfache und effiziente Art, um optimales Licht für individuelle Anforderungen zu finden.

Der Katalog PUNKT von durlum zeigt Lösungen, um die räumliche Wirkung in bestimmten Bereichen zu verstärken und diese optimal zu beleuchten. Lösungen, in denen man sich wohlfühlt!

**E** The optimal use of natural and artificial light is one of durlum's main targets.

As manufacturer of metal ceilings, light and daylight systems, we are active in research and development in this area together with well-known institutes and universities.

POINT LINE PLANE is the consequence of our developments in the area of light. This concept deals with the architectural effect of light in rooms.

Primarily, besides outstanding light quality, we are interested in finding the right light geometry for the planned application together with our partners.

Once the requirements have been defined, you can choose from suitable lights – a simple and efficient way of finding the optimal light for your individual needs.

The POINT catalogue from durlum shows solutions of how to reinforce the spatial effect in certain areas and to provide optimal lighting for them. Solutions that make you feel at home!

**F** Qu'elle soit naturelle ou artificielle, l'utilisation optimale de la lumière est l'un des objectifs principaux de durlum.

En tant que fabricant de plafonds métalliques, de systèmes d'éclairage et d'éclairage lumière du jour, nous innovons et développons dans ce domaine, en collaboration avec des instituts et universités de renom.

Les gammes POINT LIGNE PLAN sont le fruit de notre travail de conception dans le domaine de la lumière. Ce concept porte sur l'effet architectural de l'éclairage dans les locaux.

Outre une excellente qualité de la lumière, nous recherchons, en collaboration avec nos partenaires, la géométrie de l'éclairage adaptée à l'application prévue.

Une fois les exigences définies, il convient de choisir les luminaires adéquats – une manière simple et efficace pour trouver la lumière optimale adaptée aux exigences individuelles.

Le catalogue POINT de durlum présente des solutions permettant de renforcer le sentiment d'espace dans certaines pièces et de les éclairer de manière optimale. Des solutions où il fait bon vivre!



1:1 ÜBERSICHT | OVERVIEW | APERÇU > Page 04-09

**Modular Downlights**

**PUNTEO®-S20** > Page 10-13  
**PUNTEO®-S25 / -S25 3x3** > Page 14-17  
**PUNTEO®-N** > Page 18-21



**Downlights**

**PUNTEO®-Q50** > Page 22-25  
**PUNTEO®-G70** > Page 26-29  
**PUNTEO®-J85 / -J85T** > Page 30-35  
**PUNTEO®-P155** > Page 36-39  
**PUNTEO®-P245** > Page 40-43

**Zonal Lighting**

**PUNTEO®-P64** > Page 44-47

**High Power Spots**

**PUNTEO®-Y255 / -Y300** > Page 48-53

REFERENZEN | REFERENCES | RÉFÉRENCES > Page 54-63

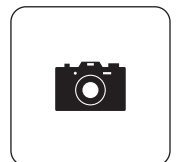

# PUNTEO®-S20

Page 10-13



# PUNTEO®-S25

Page 14-15



# PUNTEO®-S25 3X3

Page 16-17

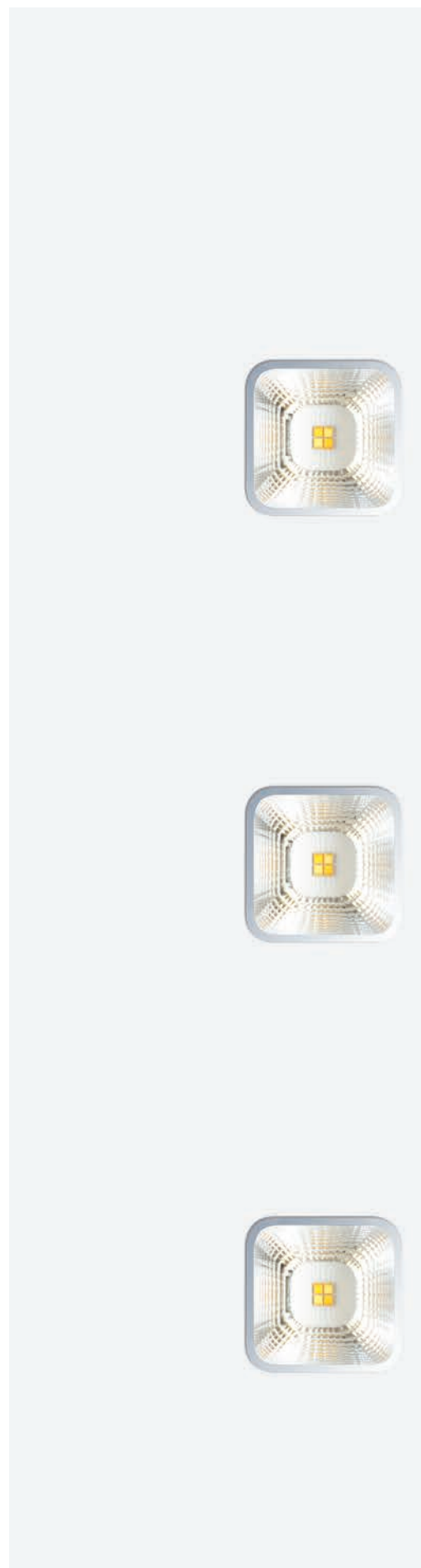

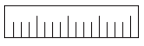

1:1

# PUNTEO<sup>®</sup>-N5X5

Page 18-21



## PUNTEO®-Q50

Page 22-25

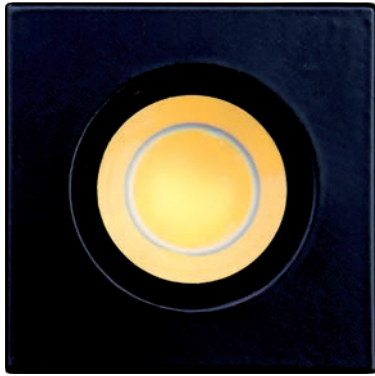

## PUNTEO®-G70

Page 26-29



## PUNTEO®-P155

Page 36-39





## PUNTEO®-J85

Page 30-33



## PUNTEO®-J85T

Page 34-35



## PUNTEO®-P245

Page 40-43



# PUNTEO®-P64

Page 44-47



# PUNTEO®-Y255

Page 48-51

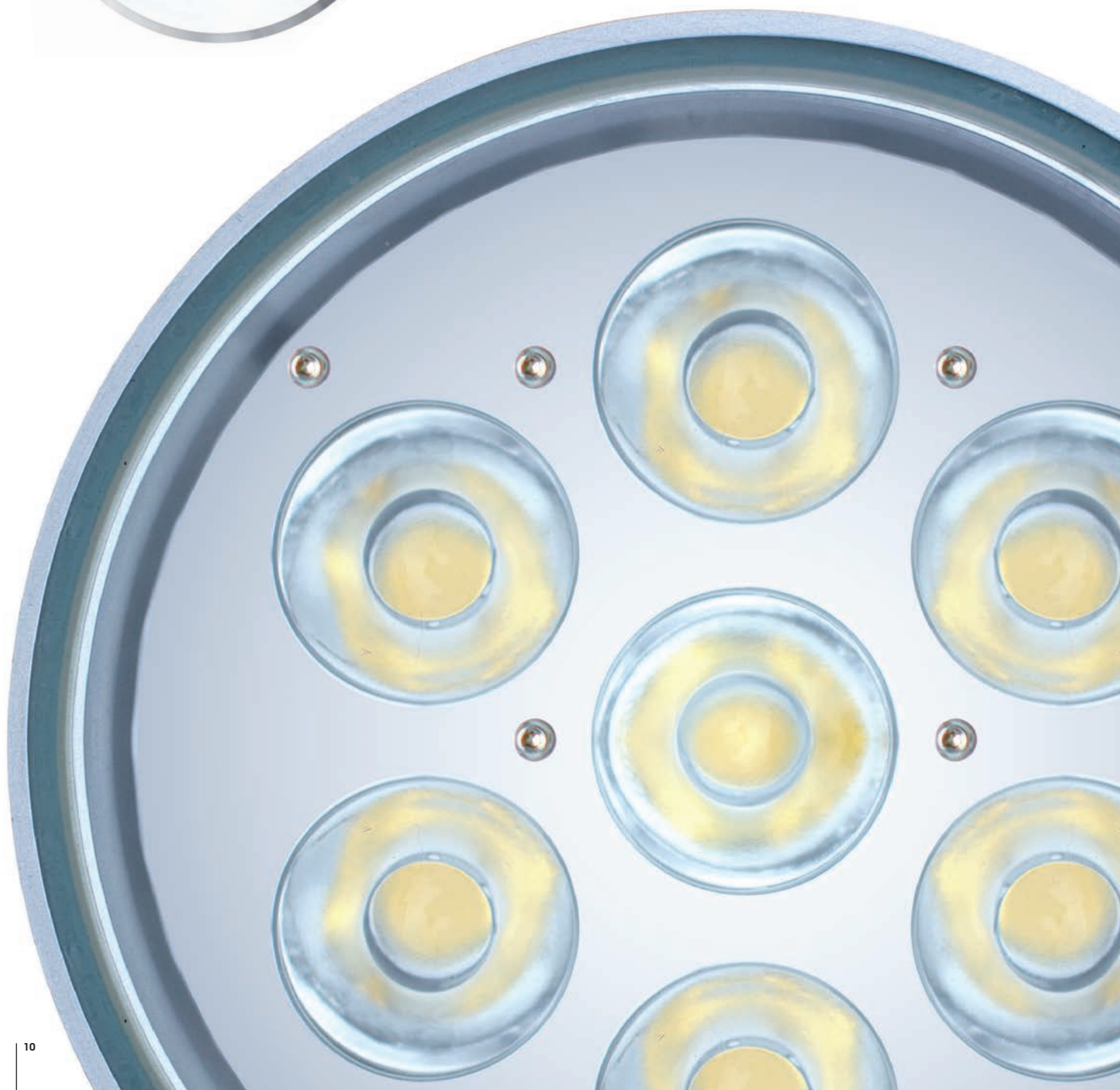

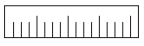

1:1

# PUNTEO®-Y300

Page 52-53





**D** PUNTEO®-S sind Minimalleuchten, die z.B. in unserem Deckensystem POLYLAM®, wie hier im vanhout.pro Büro Turnhout, verwendet werden. Minimale Optik und beste Lichttechnik zeichnen diese Downlights aus.

**E** PUNTEO®-S are tiny lamps which are used for example in our ceiling system POLYLAM®; the example shows the vanhout.pro office in Turnhout. These downlights are characterised by a discreet visual appearance and best lighting technology.

**F** Les PUNTEO®-S sont de petits luminaires qui peuvent être utilisés par exemple dans notre système de plafond POLYLAM®, comme ici dans les bureaux de vanhout.pro à Turnhout. Ces downlights se distinguent par un design minimaliste et une technique d'éclairage de pointe.



vanhout.pro office, Turnhout [BE]  
Photo: Liesbet Goetschalckx

# PUNTEO®-S20



2 x 30°

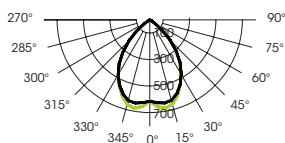

**D** PUNTEO®-S20 ist eine elegante Möglichkeit, Räume dezent zu beleuchten. Die LED-Punkte mit weichem Lichtübergang schaffen behagliche Raumsituationen und eignen sich besonders gut für Aufenthaltsbereiche und Besprechungsräume. PUNTEO®-S20 ist als Einzeleuchte im Modul 1x10 erhältlich oder als Deckenlicht-Lösung integriert in die Linearakustikdecke POLYLAM® von durlum. In Kombination mit der Metalldecke ist PUNTEO®-S20 auf Wunsch steckerfertig erhältlich, sodass es einfach und aus einer Hand vom Ausbaununternehmen an die elektrischen Zuleitungen angeschlossen werden kann.

**E** PUNTEO®-S20 is an elegant way to light rooms discreetly. The LED points with soft light transitions make the room cosy and are particularly good for lounge areas as well as for meeting rooms. PUNTEO®-S20 is available as a single luminaire in the 1x10 module or integrated as a ceiling light solution in the linear acoustics ceiling POLYLAM® by durlum. In combination with the metal ceiling, PUNTEO®-S20 can be available ready-to-plug, so that it can be easily connected to the electric supply lines by a single person from the development companies.





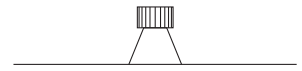

**F** PUNTEO®-S20 est une solution élégante pour un éclairage de pièce discret. Les points à LED avec transition de lumière douce génèrent une configuration agréable de la pièce et sont particulièrement adaptés aux zones d'occupation et aux salles de réunion. Disponible comme lampe unique dans un module 1x10, PUNTEO®-S20 peut également s'intégrer comme solution d'éclairage de plafond dans le plafond linéaire acoustique POLYLAM® de durlum. En combinaison avec le plafond en métal, le PUNTEO®-S20 peut être livré prêt à brancher, de sorte qu'une seule personne de l'entreprise d'aménagement intérieur suffit pour le connecter au réseau électrique.

## Finish

- integrated into the system POLYLAM®



IP20

-  350mA CC
-  Efficiency luminaire - 90lm/W
-  DALI
-  Driver inside
-  2x30°
-  Optional: Wieland plug-in system GST 18i5

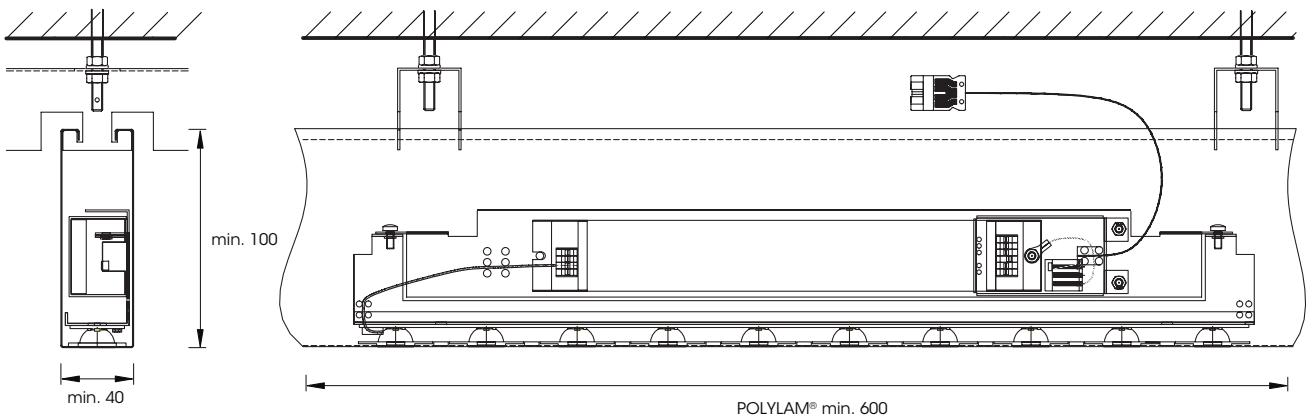
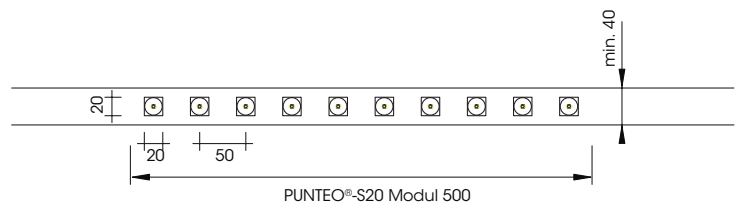
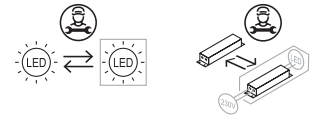

CRI > 80

**Not dimmable:** on request

### LED

10x1W, 3000K, 810lm  
10x1W, 4000K, 1060lm

### Driver

230V / 50Hz  
N°: LVG 350-035-02-01

### LED LUMINAIRE

2x30° · 10x1W · 3000K N°: PUN S20-010 W3-021  
2x30° · 10x1W · 4000K N°: PUN S20-010 W4-021

# PUNTEO®-S25



2x45° (1/10)

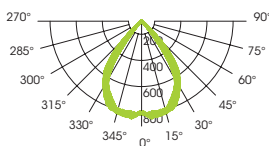

**D** PUNTEO®-S25 Tunable White ist eine moderne Milieuleuchte mit einzigartiger Farbtemperaturdynamik. Je nach Anwendung und Tageslichtsituation kann der Nutzer die Farbtemperatur flexibel und lückenlos in einer Bandbreite von 2700-5000 Kelvin anpassen. Der hohe Wirkungsgrad >90% gepaart mit hoher Leuchteneffizienz bei weichem Lichtübergang und moderner Tunable White Technologie machen Licht in neuer Qualität erlebbar – entweder als Einzelleuchte im Modul oder als Decke-Licht-Lösung optimal integriert in die Linearakustikdecke POLYLAM® von durlum im Modul 1x5.

**E** PUNTEO®-S25 Tunable White is a modern ambient lighting with unique colour temperature dynamics. According to the application and to the daylight situation, the user can adjust the colour temperature flexibly and continuously in a bandwidth of 2700-5000 kelvins. The high efficiency of more than 90% as well as the high efficiency of the luminaire with soft light transitions and modern Tunable White technology allow you to experience light in a new quality – as a single luminaire in the module or perfectly integrated as a ceiling light solution in the linear acoustics ceiling POLYLAM® of durlum in the module 1x5.

**F** Le PUNTEO®-S25 Tunable White est un éclairage d'ambiance moderne avec dynamique de température de couleur unique en son genre. Selon l'application et la luminosité naturelle, l'utilisateur peut adapter de manière flexible et en continu la couleur de température sur une plage comprise entre 2700 et 5000 kelvins. Le rendement supérieur à 90%, associé à la grande efficacité lumineuse pour une transition de lumière douce et à la technologie moderne Tunable White, permet de découvrir une nouvelle qualité de lumière – soit en tant que lampe unique dans un module, soit intégrée de manière optimale comme solution d'éclairage de plafond dans le plafond linéaire acoustique POLYLAM® de durlum en module 1x5.







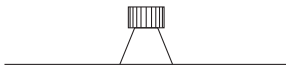

## Finish

- Integrated into the system POLYLAM®



IP20

-  350mA CC
-  Efficiency luminaire - 111 lm/W
-  DALI
-  Driver inside
-  2x45°
-  Optional: Wieland plug-in system GST 18i5

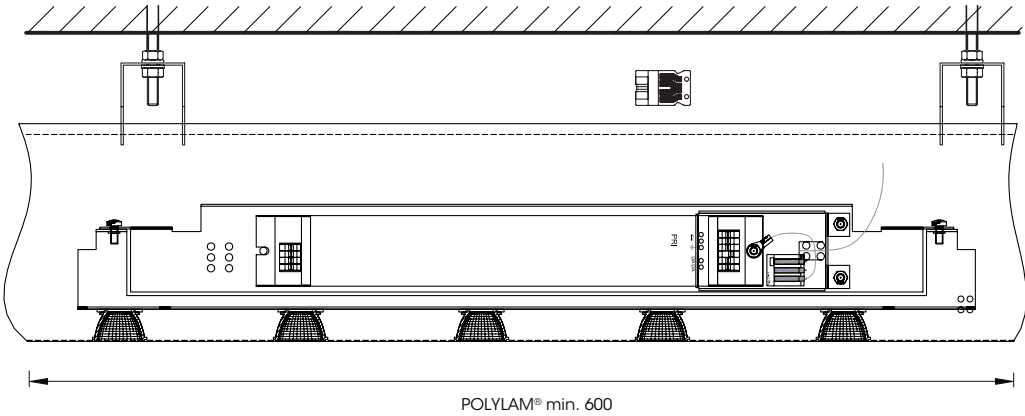
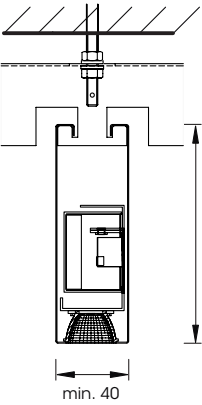
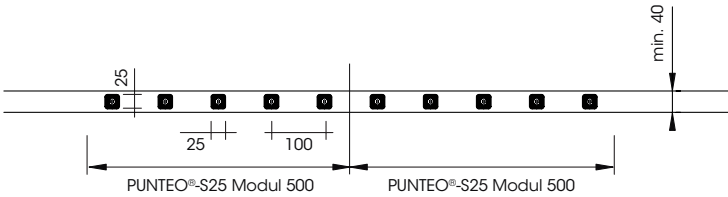
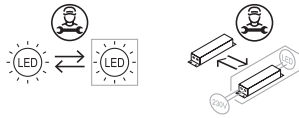

**i**

CRI > 80

**Not dimmable:** on request  
**Single color 3000K / 4000K:** on request

**LED**  
 5x4W, 2700K, 1020lm + 5000K, 1210lm

### Driver

230V / 50Hz  
 N°: LVG 350-070-02-01  
 For 2 modules

### LED LUMINAIRE

2x45° · 5x4W · 2700 / 5000K N°: PUN S25-010 W0-021

# PUNTEO®-S25 3X3

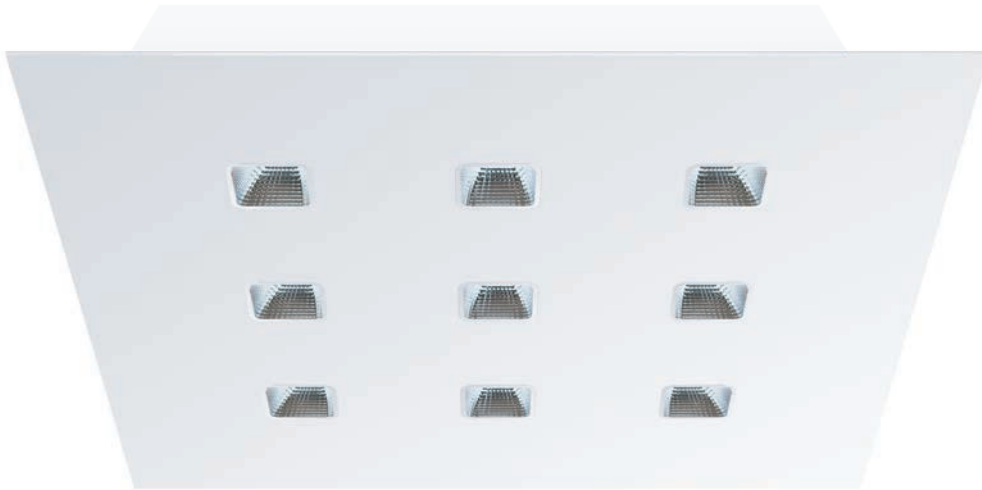

2x45° (1/10)

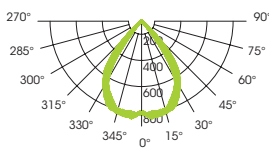

**D** PUNTEO®-S25 Tunable White im Modul 3x3 ist eine moderne Milieuleuchte mit einzigartiger Farbtemperaturdynamik. Je nach Anwendung und Tageslichtsituation kann der Nutzer die Farbtemperatur flexibel und lückenlos in einer Bandbreite von 2700-5000 Kelvin anpassen. Der hohe Wirkungsgrad >90% gepaart mit hoher Leuchteneffizienz bei weichem Lichtübergang und moderner Tunable White Technologie machen Licht in neuer Qualität erlebbar – entweder als Einzeleuchte oder als Modul integriert in durlum Metaldeckensysteme.

**E** PUNTEO®-S25 Tunable White in the module 3x3 is a modern ambient lighting with unique colour temperature dynamics. According to the application and to the daylight situation, the user can adjust the colour temperature flexibly and continuously in a bandwidth of 2700-5000 kelvins. The high efficiency of more than 90% as well as the high efficiency of the luminaire with soft light transitions and modern Tunable White technology allow you to experience light in a new quality – as a single luminaire or as module integrated in durlum metal ceiling systems.





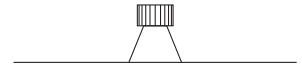

**F** Le PUNTEO®-S25 Tunable White en module 3x3 est un éclairage d'ambiance moderne avec dynamique de température de couleur unique en son genre. Selon l'application et la luminosité naturelle, l'utilisateur peut adapter de manière flexible et en continu la couleur de température sur une plage comprise entre 2700 et 5000 kelvins. Le rendement supérieur à 90%, associé à la grande efficacité lumineuse pour une transition de lumière douce et à la technologie moderne Tunable White, permet de découvrir une nouvelle qualité de lumière – soit en tant que lampe unique, soit intégrée comme un module dans les système des plafondes métalliques de durlum.

## Finish

- Powder coated RAL 9010



IP20

-  350mA CC
-  Efficiency luminaire - 111 lm/W
-  DALI
-  Driver inside
-  2x45°
-  Optional: Wieland plug-in system GST 18i5

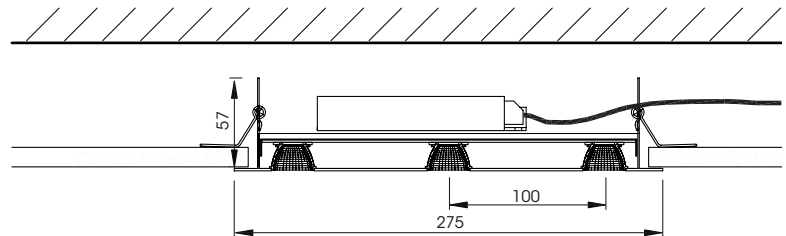
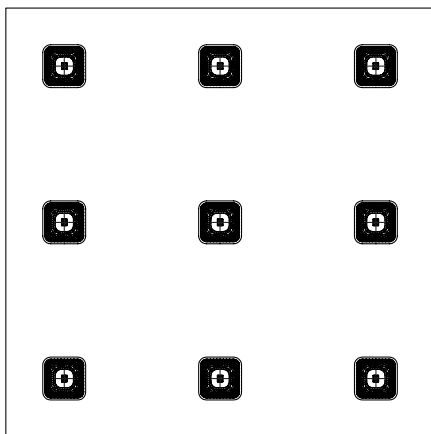
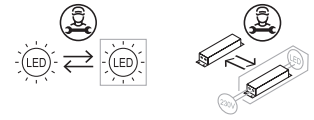

CRI > 80

**Not dimmable:** on request

### LED

9x4W, 2700K, 1830lm + 5000K, 2180lm

## Driver

230V / 50 2x30°Hz  
N°: LVG 350-070-02-01

## LED LUMINAIRE

2x45° · 9x4W · 2700K / 5000K N°: PUN S25-275 W0-021





## PUNTEO®-N

**D** Kleine, raffiniert in den Raum gesetzte Akustik-Deckensegel egalisieren die schallharten Oberflächen im BASF Feierabendhaus Ludwigshafen. Gleichzeitig beleuchten sie diesen optimal mit den integrierten PUNTEO®-N Modulen, die sich ihrerseits durch innovative Lichttechnik und minimalste Optik auszeichnen.

**E** Small and subtly-arranged acoustic raft ceilings equalise the reverberant surfaces in the BASF-Feierabendhaus in Ludwigshafen. At the same time, they illuminate the room optimally using integrated PUNTEO®-N modules which are characterised by innovative lighting technology and a discreet visual appearance.

**F** Les petits plafonds flottants acoustiques à l'agencement raffiné équilibrent la réverbération des surfaces du Feierabendhaus de BASF à Ludwigshafen. Par ailleurs, ils garantissent un éclairage optimal grâce aux modules PUNTEO®-N intégrés, qui se distinguent de leur côté par une technologie d'éclairage innovante et un design minimaliste.



BASF Feierabendhaus, Ludwigshafen [D]  
Photo: durlum

# PUNTEO®-N 5X5



2 x 30°

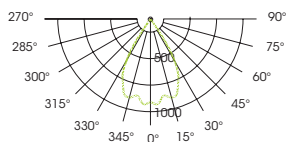

**D** Für die klare, reduzierte Architektur ist PUNTEO®-N besonders zu empfehlen. Die Minimalleuchten mit symmetrischer oder asymmetrischer Lichttechnik lassen sich optimal in durlum Metalldeckensysteme, aber auch als Leuchtenmodul in herkömmliche Decken integrieren. Durch die besondere PUNTEO®-N-Technik sind keine Leuchten mehr zu sehen, sondern nur noch 10mm kleine Öffnungen in einer Trägerplatte, durch die das Licht über spezielle Linsen mittels Überkreuzstrahlung austritt. Mit einem Wirkungsgrad von >80% erfüllen PUNTEO®-N außerdem sämtliche Anforderungen eines effizienten Lichtsystems.

**E** For a clear, reduced architecture, we particularly recommend PUNTEO®-N. These tiny lamps with symmetric or asymmetric light technique can be optimally integrated in durlum metal ceiling systems but also as light module in normal ceilings. Thanks to the particular PUNTEO®-N technique, no lamp can be seen any more, but only 10mm small apertures in a carrier plate through that the light comes out through special lenses of wide angle reflectors. At an efficiency of more than 80%, PUNTEO®-N also comply with all requirements of an efficient lighting system.

**F** PUNTEO®-N est la solution idéale pour une architecture claire et réduite. Ces petits luminaires avec technique d'éclairage symétrique ou asymétrique s'intègrent tout aussi bien aux plafonds métalliques durlum que, en tant que modules lumineux, aux plafonds classiques. Grâce à la technologie spécifique PUNTEO®-N, on ne voit plus de lampes mais juste une plaque support percée de petites ouvertures de 10mm laissant passer la lumière grâce à des réflecteurs grand angle et des lentilles spéciales. Grâce à un rendement supérieur à 80%, le modèle PUNTEO®-N satisfait en outre à toutes les exigences d'un système d'éclairage efficient.

## Finish

- Powder coated RAL 9010

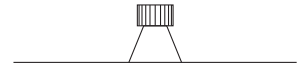

IP20 IP65



500mA CC



Efficiency luminaire - 73lm/W



DALI



Driver outside



2x30°

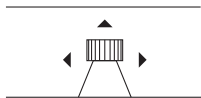
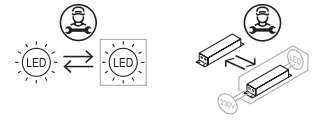

Empty space =  $\geq 60$  mm



Ceiling cut = **257x257 mm**

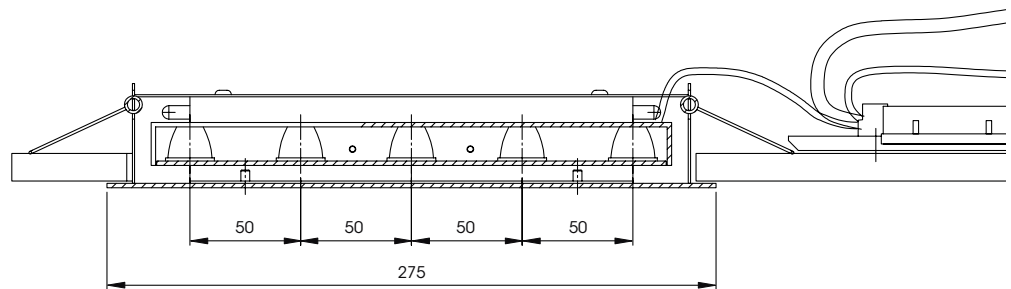

**Not dimmable:** on request  
Also available in IP65 as 1x2 module

**LED**  
4000K, 3625lm  
Tunable white on request

## Driver

**18W DALI**  
500mA / 18W · 179x31 x 31,5mm  
N°: LVG 500-060-03-01

Other drivers on request

## LED LUMINAIRE

2x30° · 40W · 4000K N°: PUN N275-025 W4-03





**D** Im Sperrengeschoss des Hauptbahnhofs München kamen die dezenten PUNTEO®-Q50 LED-Leuchten zum Einsatz, die im Zusammenspiel mit der GEO®-Rasterdecke von durlum eine homogene Einheit bilden und für optimale Ausleuchtung der gesamten Fläche sorgen.

**E** In the mezzanine floor in the central station in Munich, the discreet lights PUNTEO®-Q50 are used which form, in combination with the open-cell ceiling GEO® of durlum, a homogeneous unit and ensure an optimum illumination of the whole area.

**F** L'entresol de la gare centrale de Munich est éclairé par les discrets luminaires PUNTEO®-Q50, qui créent un tout homogène en combinaison avec le plafond alvéolaire GEO® de durlum et garantissent un éclairage optimal de toute la surface.



Subway mezzanine central station,  
Munich [D]  
Photo: Felix Meyer

# PUNTEO®-Q50



2 x 25°

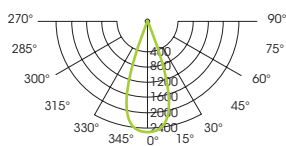

2 x 35°

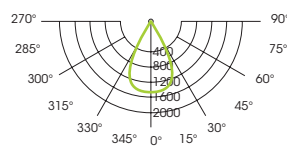

2 x 45°

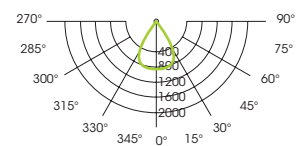

**D** Das breitstrahlende LED-Downlight PUNTEO®-Q50 entfaltet seine Lichtwirkung dezent. Die kompakte Form in schwarzer Optik fugt sich ab einer Zellgroe von 75mm unauffallig ohne Modulplatte in die Rasterdecke GEO® von durlum ein. Die Leuchte mit der Schutzart IP65 kann selbstverstandlich auch in andere Metalldecken integriert werden. In Kombination mit der Decke ist PUNTEO®-Q50 auf Wunsch steckerfertig erhaltlich, sodass es einfach und aus einer Hand vom Ausbaununternehmen an die elektrischen Zuleitungen angeschlossen werden kann.

**E** The wide-beam LED downlight PUNTEO®-Q50 displays a discreet light. From a cell size of 75mm, the compact form in black design fits exactly in the open-cell ceiling GEO® of durlum without needing a module plate. The lamp with protection class IP65 can of course be integrated in other metal ceilings too. In combination with the ceiling, PUNTEO®-Q50 can be available ready-to-plug, so that it can be easily connected to the electric supply lines by a single person from the development companies.

**F** Offrant un large clairage, le downlight  LED PUNTEO®-Q50 offre une lumire discrte.  partir d'une taille de cellule de 75mm, cette lampe compacte de couleur noire s'intgre parfaitement au plafond alvolaire GEO® de durlum sans ncessiter de plaque modulaire. Bien videmment, ce luminaire avec catgorie de protection IP65 peut galement s'intgrer  d'autres plafonds en mtal. En combinaison avec le plafond, le PUNTEO®-Q50 peut tre livr prt  brancher, de sorte qu'une seule personne de l'entreprise d'amnagement intrieur suffit pour le connecter au rseau lectrique.

## Finish

- Aluminium black, glass

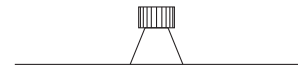

IP65



350mA CC



DALI



Separate driver



2x25°, 2x35°, 2x45°



Wieland plug-in system

Primary connector: RST20i5 cod. turquoise blue

Secondary connector: RST08i2 cod. pebble grey

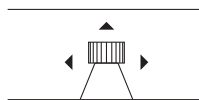
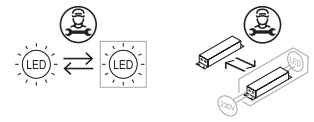

Empty space =  $\geq 60$ mm

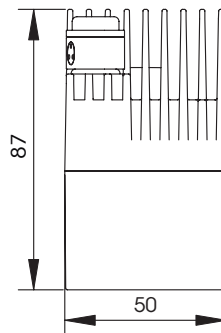

2x25°

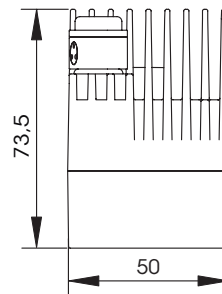

2x35°

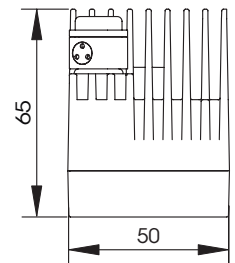

2x45°



CRI > 80

**Not dimmable:** on request

**8W, 2x15°:** on request

### LED

14W, 3000 K, 1779lm

14W, 4000 K, 1860lm

## Driver

### 30W DALI

350mA / 30W · 121.5x53.5x26mm

N°: CVG 000-030-02-05

Other drivers on request

## LED LUMINAIRE

2x45° · 14W · 3000K	N°: PUN Q050 S03c 830 01
2x45° · 14W · 4000K	N°: PUN Q050 S03c 840 01*
2x35° · 14W · 3000K	N°: PUN Q050 S03a 830 01
2x35° · 14W · 4000K	N°: PUN Q050 S03a 840 01*
2x25° · 14W · 3000K	N°: PUN Q050 S03b 830 01
2x25° · 14W · 4000K	N°: PUN Q050 S03b 840 01

\*Our standard versions.





**D** Der Ausblick, die gewählte Einrichtung und insbesondere die Glaskörper des PUNTEO®-G70 verleihen dem Dozentenfoyer der ETH Zürich ein besonderes Ambiente. Die Downlights durchbrechen die feinen Linien der Linearrasterdecke STAR 3® und bilden genau deshalb mit ihr ein abgestimmtes Ganzes.

**E** The panorama, the selected furnishing and especially the glass body of the PUNTEO®-G70 contribute to the special atmosphere of the Dozentenfoyer of the EHT Zurich. The downlights interrupt the fine lines of the linear open cell blade ceiling STAR 3® and that's exactly why they form a harmonious whole.

**F** Le foyer des professeurs de l'EPF de Zurich se distingue par une atmosphère unique qui lui est conférée par la vue, mais aussi par son aménagement, et en particulier par les corps en verre des PUNTEO®-G70. Les downlights contrastent avec les fines lignes du plafond à trame linéaire STAR 3®, formant ainsi un tout harmonieux.



Dozentenfoyer, ETH Zurich [CH]  
Photo: Oliver Kern

# PUNTEO®-G70



Medium beam

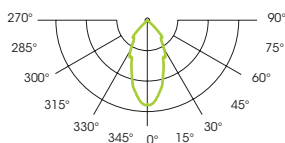

**D** PUNTEO®-G70 verkörpert besondere Eleganz. Der Glasreflektor in kubischem Design überzeugt durch brillantes Licht bei weichem Lichtübergang und sorgt für das richtige Ambiente in Restaurants oder Shops. Entwickelt für die Integration in die Linearrasterdecke STAR 3®, durchbricht er die dezente Strenge klassischer Decken und setzt bewusst Akzente. In Kombination mit der Decke ist PUNTEO®-G70 auf Wunsch steckerfertig erhältlich, sodass es einfach und aus einer Hand vom Ausbauunternehmen an die elektrischen Zuleitungen angeschlossen werden kann.

**E** The PUNTEO®-G70 embodies particular elegance. The glass reflector in cubic design appeals by its brilliant light and soft light transitions and cares for the right ambient in restaurants or shops. Developed for the integration in the linear grid ceiling STAR 3®, it changes from the discreet severity of classical ceilings and sets deliberate new tones. In combination with the ceiling, PUNTEO®-G70 can be available ready-to-plug, so that it can be easily connected to the electric supply lines by a single person from the development companies.

**F** Le PUNTEO®-G70 incarne une élégance particulière. Le réflecteur en verre au design cubique séduit par sa luminosité brillante pour une transition de lumière douce et garantit une ambiance idéale pour les restaurants ou les boutiques. Conçu pour être intégré au plafond à trame linéaire STAR 3®, il brise la discrète austérité des plafonds classiques et génère des touches esthétiques. En combinaison avec le plafond, le PUNTEO®-G70 peut être livré prêt à brancher, de sorte qu'une seule personne de l'entreprise d'aménagement intérieur suffit pour le connecter au réseau électrique.

## Finish

- Aluminium anodised, glass

 700mA CC

 DALI

 Driver outside

 Medium beam

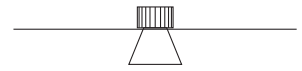

IP20

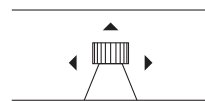
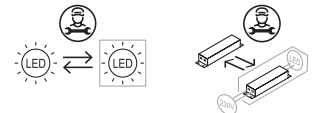

Empty space =  $\geq 60$  mm

Situation for metal ceiling

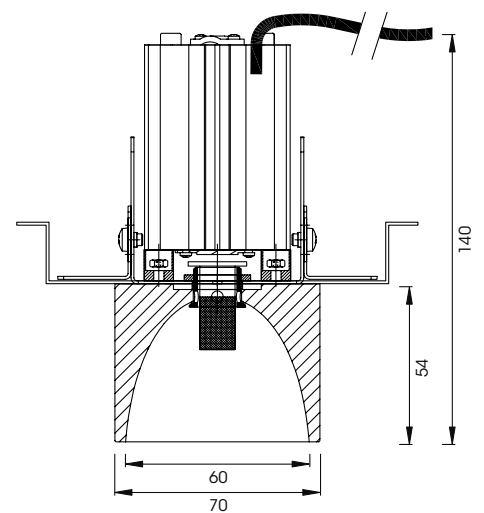

CRI >80

**Not dimmable:** on request

**Other ceiling types:** on request

### LED

13W, 3000K, 900lm

13W, 4000K, 1055lm

## Driver

### 30W DALI

700mA / 30W · 207x42x31 mm

N°: LVG 700-030-02-01

Other drivers on request

## LED LUMINAIRE

### Grid ceiling

13W · 3000K      N°: PUN G070-013 N3-01

13W · 4000K      N°: PUN G070-013 N4-01

### Plaster ceiling

13W · 3000K      N°: PUN G070-013 N3-03

13W · 4000K      N°: PUN G070-013 N4-03





## PUNTEO®-J85



**D** Unser Downlight mit dem breitesten Anwendungsspektrum ist der PUNTEO®-J85. In Verbindung mit der Decke LOOP® wurde er im Restaurant George in Zürich eingesetzt und trägt maßgeblich zum ganz besonderen Wohlfühlambiente bei.

**E** The downlight with the widest range of application is the PUNTEO®-J85. It has been used in combination with the LOOP® ceiling in the Restaurant George in Zurich and contributes significantly to the feel-good atmosphere.

**F** Notre downlight le plus largement utilisé est le PUNTEO®-J85. Il est utilisé au restaurant George à Zurich, en combinaison avec le plafond LOOP®, et contribue largement à l'atmosphère de bien-être qui y règne.



HQ Volksbank Bolzano, South Tyrol [IT]  
Photo: Oskar DaRiz

# PUNTEO®-J85



2x20° (1/10)

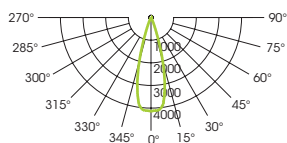

2x30° (1/10)

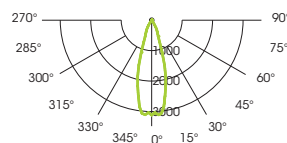

2x40° (1/10)

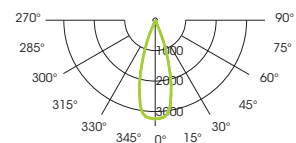





**D** Das LED-Downlight PUNTEO®-J85 ist vielseitig einsetzbar. Die lichtstarke Einbauleuchte garantiert brillante Lichtqualität bei weichem Lichtübergang. Sie kann optimal in das durlum Metalldeckensystem LOOP® integriert werden und eignet sich auch hervorragend für Gipskarton- und Betondecken.

**E** The LED downlight PUNTEO®-J85 can be used for multiple purposes. This built-in luminaire with intense luminosity guarantees brilliant light quality and soft light transitions. It can be ideally integrated into durlum's metal ceiling system LOOP® and is also highly suitable for plasterboard and concrete ceilings.

**F** Le downlight à LED PUNTEO®-J85 est polyvalent. Ce plafonnier à la luminosité intense garantit une lumière brillante et de qualité pour une transition de lumière douce. Il s'intègre idéalement dans le système de plafond métallique LOOP® mais s'adapte également parfaitement aux plafonds en béton ou en plaques de plâtre.

## Finish

- Aluminium anodised, high-gloss aluminium

-  500mA CC / 700mA CC
-  Efficiency luminaire - 88lm/W
-  DALI
-  Driver outside
-  2x20°, 2x30°, 2x40°

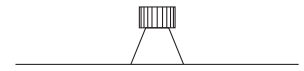

IP20

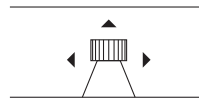
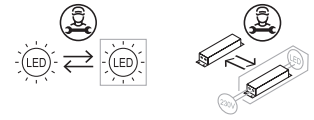

Empty space =  $\geq 60$  mm



Ceiling cut =  $\varnothing 74$  mm

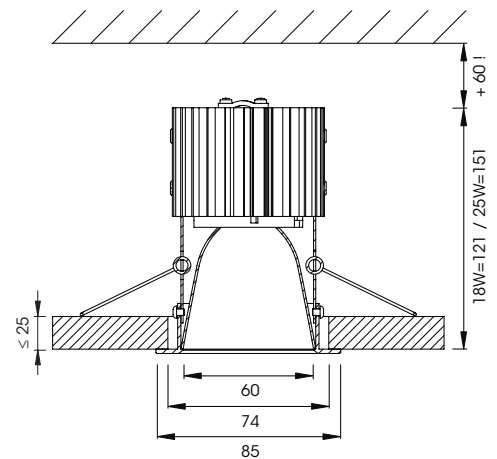

CRI > 80

**Not dimmable:** on request

### LED

18W, 3000K, 2286lm  
 18W, 4000K, 2390lm  
 25W, 3000K, 3012lm  
 25W, 4000K, 3149lm

## Driver

### 18W DALI

500mA / 18W · 207x42x31 mm  
 N°: LVG 500-020-02-01

### 25W DALI

700mA / 25W · 207x42x31 mm  
 N°: LVG 700-030-02-01

Other drivers on request

## LED LUMINAIRE

2x20° · 18W · 3000K	N°: PUN J085-018 N3-03
2x20° · 18W · 4000K	N°: PUN J085-018 N4-03
2x20° · 25W · 3000K	N°: PUN J085-025 N3-03
2x20° · 25W · 4000K	N°: PUN J085-025 N4-03
2x30° · 18W · 3000K	N°: PUN J085-018 M3-03
2x30° · 18W · 4000K	N°: PUN J085-018 M4-03
2x30° · 25W · 3000K	N°: PUN J085-025 M3-03
2x30° · 25W · 4000K	N°: PUN J085-025 M4-03
2x40° · 18W · 3000K	N°: PUN J085-018 W3-03
2x40° · 18W · 4000K	N°: PUN J085-018 W4-03
2x40° · 25W · 3000K	N°: PUN J085-025 W3-03
2x40° · 25W · 4000K	N°: PUN J085-025 W4-03

# PUNTEO®-J85T



2x20° (1/10)

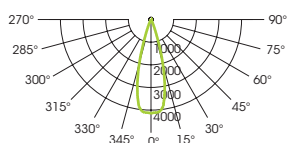

2x30° (1/10)

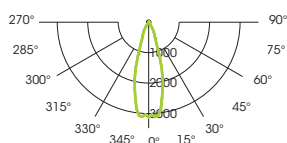

2x40° (1/10)

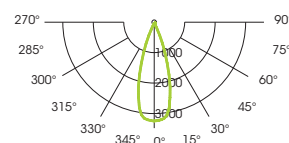

**D** Das LED-Downlight PUNTEO®-J85T ist die schwenkbare Variante der PUNTEO®-J Produktfamilie. Vielseitig einsetzbar garantiert die lichtstarke Einbauleuchte brillante Lichtqualität bei weichem Lichtübergang. Sie kann optimal in durlum Metalldeckensysteme integriert werden und eignet sich auch hervorragend für Gipskarton- und Betondecken.

**E** The LED downlight PUNTEO®-J85T is the swivelling version of the PUNTEO®-J family of products. This multi-purpose built-in luminaire with intense luminosity guarantees brilliant light quality and soft light transitions. It can be ideally integrated into durlum's metal ceiling systems and is also highly suitable for plasterboard and concrete ceilings.

**F** Le downlight à LED PUNTEO®-J85T est la variante pivotante de la gamme de produits PUNTEO®-J. Ce plafonnier polyvalent à la luminosité intense garantit une lumière brillante et de qualité pour une transition de lumière douce. Il s'intègre idéalement dans les systèmes de plafond métallique mais est également parfaitement adapté pour les plafonds en béton ou en plaques de plâtre.

## Finish

- Aluminium anodised, high-gloss aluminium

 500mA CC / 700mA CC

 Efficiency luminaire - 88lm/W

 DALI

 Driver outside

 2x20°, 2x30°, 2x40°

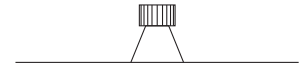

IP20

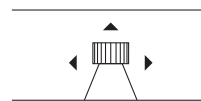
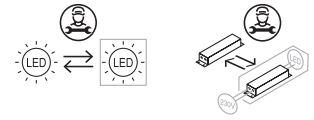

Empty space =  $\geq 60$ mm



Ceiling cut =  $\varnothing 110$ mm

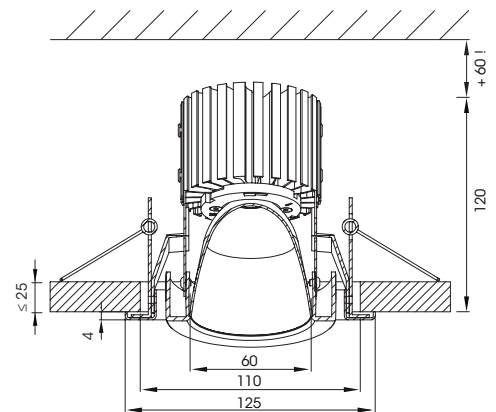

CRI > 80

**Not dimmable:** on request

### LED

18W, 3000K, 2286lm  
18W, 4000K, 2390lm  
25W, 3000K, 3012lm  
25W, 4000K, 3149lm

## Driver

### 18W DALI

500mA / 18W · 207x42x31 mm  
N°: LVG 500-020-02-01

### 25W DALI

700mA / 25W · 207x42x31 mm  
N°: LVG 700-030-02-01

Other drivers on request

## LED LUMINAIRE

2x20° · 18W · 3000K N°: PUN J085T-018 N3-03  
2x20° · 18W · 4000K N°: PUN J085T-018 N4-03  
2x20° · 25W · 3000K N°: PUN J085T-025 N3-03  
2x20° · 25W · 4000K N°: PUN J085T-025 N4-03

2x30° · 18W · 3000K N°: PUN J085T-018 M3-03  
2x30° · 18W · 4000K N°: PUN J085T-018 M4-03  
2x30° · 25W · 3000K N°: PUN J085T-025 M3-03  
2x30° · 25W · 4000K N°: PUN J085T-025 M4-03

2x40° · 18W · 3000K N°: PUN J085T-018 W3-03  
2x40° · 18W · 4000K N°: PUN J085T-018 W4-03  
2x40° · 25W · 3000K N°: PUN J085T-025 W3-03  
2x40° · 25W · 4000K N°: PUN J085T-025 W4-03





## PUNTEO®-P155

**D** PUNTEO®-P155 Milieuleuchten setzen brillante Akzente. Durch eine integrierte Milieusteuerung können PUNTEO®-P155 die jeweilig herrschende Lichtstimmung unterstützen [tagsüber: Licht mit kalter Lichtfarbe, abends: Licht mit warmer Lichtfarbe]. Das Bild zeigt die Beleuchtung der Stadthalle Schopfheim nach der Umrüstung auf PUNTEO®-P155.

**E** PUNTEO®-P155 ambient lights provide brilliant trends. With our integrated ambient control, PUNTEO®-P155 can support the prevalent light atmosphere [during the day: light with a cold light colour, in the evening: light with a warm light colour]. The picture shows the illumination of the municipal hall in Schopfheim after the building has been equipped with PUNTEO®-P155.

**F** L'éclairage d'ambiance PUNTEO®-P155 génère des touches de brillance. Grâce à une commande d'ambiance intégrée, les luminaires PUNTEO®-P155 peuvent apporter une note supplémentaire à l'ambiance existante [pendant la journée : de la lumière à tonalité froide, le soir : de la lumière à tonalité chaude]. Sur l'image, vous pouvez voir la salle polyvalente de Schopfheim après le passage aux PUNTEO®-P155.



Municipal hall, Schopfheim [D]  
Photo: Rainer Keser

# PUNTEO®-P155



2x35°

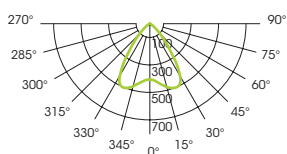

**D** Die Milieuleuchte PUNTEO®-P155 Tunable White setzt brillante Akzente. Je nach Anwendung und Tageslichtsituation kann der Nutzer die Farbtemperatur des ästhetischen LED-Downlights flexibel und lückenlos in einer Bandbreite von 2700-5000 Kelvin anpassen. Die lichtstarke Leuchte ist besonders geeignet für Präsentations- und Veranstaltungsräume und fügt sich harmonisch in die architektonische Umgebung ein.

**E** The ambient lighting PUNTEO®-P155 Tunable White sets brilliant tones. According to the application and to the daylight situation, the user can adjust the colour temperature of this aesthetic LED downlight flexibly and continuously in a bandwidth of 2700-5000 kelvins. The intense luminaire is particularly appropriate for presentation and conference rooms and fits perfectly in the architectural environment.

**F** L'éclairage d'ambiance PUNTEO®-P155 Tunable White apporte des touches de brillance. Selon l'application et la luminosité naturelle, l'utilisateur peut adapter de manière flexible et en continu la couleur de température de cet esthétique downlight à LED sur une plage comprise entre 2700 et 5000 kelvins. Cette lampe puissante est particulièrement adaptée pour les salles de présentation et de conférence et s'intègre harmonieusement dans l'environnement architectonique.



## Finish

- Aluminium matt

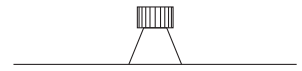

IP20

 2x700mA CC

 DALI

 Driver external (2x)

 2x35°

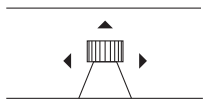
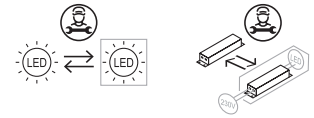

Empty space =  $\geq 100$  mm



Ceiling cut =  $\varnothing 145$  mm

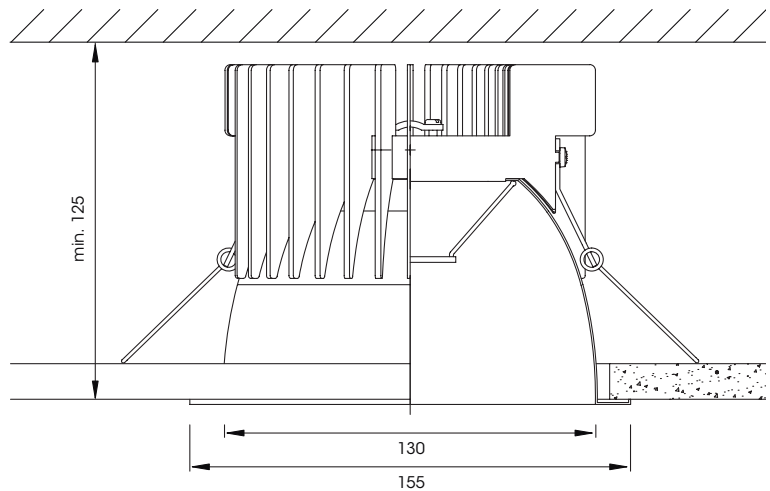

CRI > 85

**Not dimmable:** on request

### LED

3x6W, 2700K, 1170lm  
 3x6W, 5000K, 1470lm  
 2x3x6W, 3000K, 2550lm  
 2x3x6W, 4000K, 2910lm

## Driver

### DALI

207x42x31 mm  
 2x N°: LVG 700-030-02-01

**2 units per luminaire are required**

Other drivers on request

## LED LUMINAIRE

2x35° · 36W · 2700/5000K N°: PUN P155-036 W0-01  
 2x35° · 36W · 3000K N°: PUN P155-036 W3-01  
 2x35° · 36W · 4000K N°: PUN P155-036 W4-01



## PUNTEO®-P245

**D** PUNTEO®-P245 ist das Chamäleon unserer PUNTEO®-Serie. Das breite Weiß-Spektrum erlaubt es, Räume in verschiedene Stimmungen zu setzen und damit verschiedensten Nutzungsansprüchen gerecht zu werden. Insbesondere für Verkaufsräume, aber auch für öffentliche Räume ist der PUNTEO®-P245 die optimale Wahl.

**E** PUNTEO®-P245 is the most adaptive light of our PUNTEO® series. The broad spectrum of white light can create different moods and is therefore ideal for a lot of applications. Especially for sales rooms but also for public areas, PUNTEO®-P245 is the optimum choice.

**F** Le PUNTEO®-P245 est le caméléon dans notre série PUNTEO®. Sa large gamme de tons de blanc permet de modifier l'ambiance de la pièce pour répondre au mieux à l'utilisation souhaitée. Le PUNTEO®-P245 est le meilleur choix, que vous souhaitiez équiper un espace de vente ou une salle officielle.

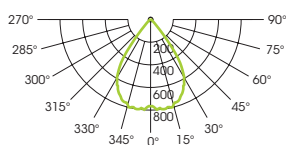

Photo: Thomas Krauss

# PUNTEO®-P245



2x45°



**D** Lichtstark, effizient und flexibel – so präsentiert sich PUNTEO®-P245 Tunable White. Die LED-Leuchte mit weichem Lichtübergang kann die Farbtemperatur lückenlos zwischen 2700-5000 Kelvin anpassen und die herrschende Lichtstimmung bedarfsgerecht unterstützen. PUNTEO®-P245 eignet sich besonders für großflächige Anwendungen wie Einkaufszentren oder Verkehrsbauten.

**E** Intense, efficient and flexible – these are the highlights of the PUNTEO®-P245 Tunable White. The LED lamp with soft light transitions can adjust its colour temperature continuously between 2700 and 5000 kelvins and support the prevailing light ambience as needed. The PUNTEO®-P245 is particularly appropriate for extensive applications like shopping centres or transport facilities.

**F** Puissance, efficacité et flexibilité – voilà les caractéristiques du PUNTEO®-P245 Tunable White. Ce luminaire à LED avec transition de lumière douce peut adapter sa température de couleur en continu entre 2700 et 5000 kelvins et renforcer l'ambiance lumineuse en fonction des besoins. PUNTEO®-P245 est particulièrement adapté aux surfaces importantes comme les centres commerciaux ou les infrastructures de transport.

## Finish

- Aluminium matt

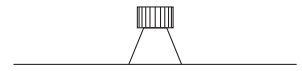

IP20



700mA CC



Efficiency luminaire - 111 lm/W



DALI



Driver external



2x45°



Optional: Wieland plug-in system  
GST 18i5

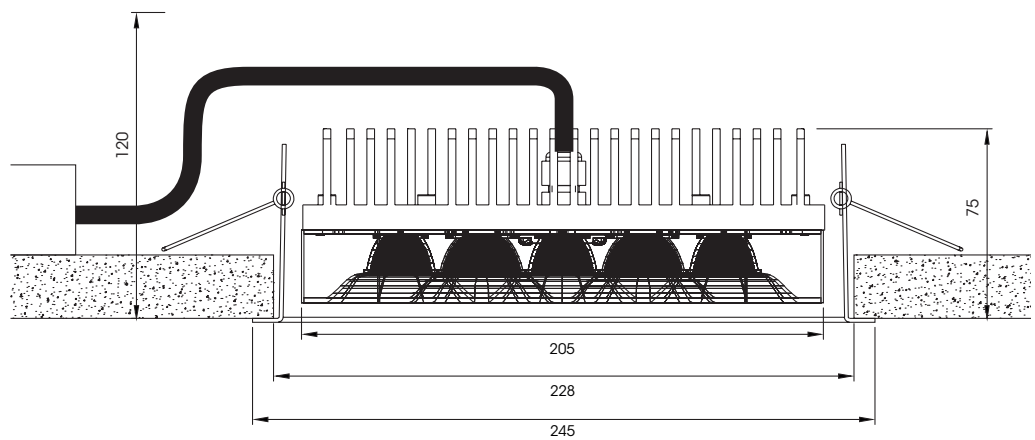
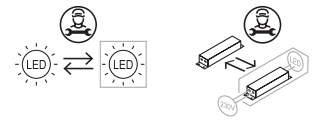

**Not dimmable:** on request

### LED

7x8W, 4000K, 5670lm

## Driver

### DALI

700mA / 75W · 241 x 60 x 307 mm

## LED LUMINAIRE

2x45° · 56W · 4000K

N°: PUN P245-056 W4-01

2x45° · 56W · 2700K / 5000K

N°: PUN P245-056 W0-01



## PUNTEO®-P64

**D** PUNTEO®-P64 setzt Akzente. Wie hier am Giants-Causeway Visitor Centre in Antrim UK, lassen sich mit ihm architektonische Details in Szene setzen. Genauso gut eignet sich der Strahler aber auch für andere Vertikalbeleuchtungen wie Treppen, Absätze o.a.

**E** PUNTEO®-P64 provides lighting effects. In the Giant's Causeway Visitor Centre in Antrim UK, it is used to highlight the impressive architecture of the building. The spotlight, however, is also ideal for other vertical lighting applications, such as stairs and landings.

**F** Le PUNTEO®-P64 crée des touches uniques. Il met en scène les détails architectoniques, comme ici, au centre des visiteurs de la Chaussée des Géants à Antrim (Royaume-Uni). Mais ce spot est tout aussi adapté pour des éclairages verticaux, comme dans les escaliers, sur les paliers, etc.



Giant's Causeway Visitor Centre,  
Antrim [UK]  
Photo: Hufton + Crow

# PUNTEO®-P64



2x10°

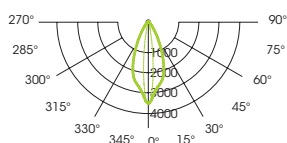

**D** PUNTEO®-P64 ist eine LED-Leuchte, konzipiert für den Einsatz an Wegen und Treppen. Die aus der Horizontalen beleuchtete Fläche wird als wesentlich angenehmer und weiträumiger wahrgenommen. Hochwertiges Finish in matt poliertem Edelstahl und Glas unterstreicht die technische Qualität von PUNTEO®-P64.

**E** The PUNTEO®-P64 is a LED lamp designed for a use in ways and stairs. The horizontal-lighted zone is perceived as much friendlier and spacious. Top-quality finish in matt polished stainless steel and glass enhances the technical quality of the PUNTEO®-P64.

**F** Le PUNTEO®-P64 est un luminaire à LED conçu pour éclairer chemins et escaliers. Illuminée depuis l'horizontale, la surface est perçue comme étant nettement plus agréable et plus spacieuse. La finition haut de gamme en inox et verre mat poli souligne la qualité technique du PUNTEO®-P64.



## Finish

- Stainless steel,  
cover matt polished, glass-flush



24V DC



Efficiency luminaire - 70lm/W



DALI



Driver outside



2x10°



IP64

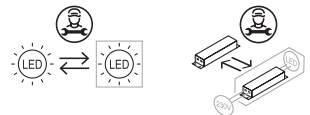

Ceiling/Wall cut =  $\varnothing$  48 mm

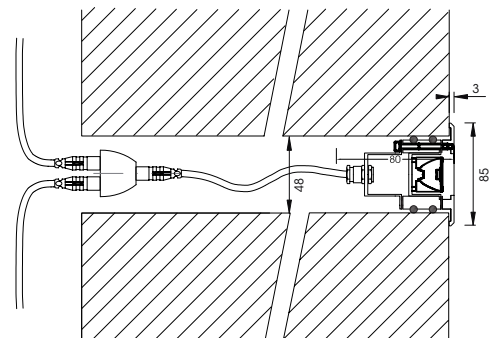

**Not dimmable:** on request  
**Other light distributions:** on request

### LED

3W, 3000K, 140lm  
3W, 4000K, 160lm

## Driver

### 75W DALI

24V / 75W · 220x46x44 mm  
N°: LVG 024-075-08-01

Other drivers on request

## LED LUMINAIRE

2x10° · 3W · 3000K N°: PUN P064-003 N3-01  
2x10° · 3W · 4000K N°: PUN P064-003 N4-01



**D** PUNTEO®-Y setzen starke Akzente. Die Hochleistungsstrahler mit speziellen Hybrid-Kristalllinsen wurden entwickelt, um einzelne Objektbereiche oder Interieurs zu fokussieren oder mittels Lichtumlenktechnik zu beleuchten. Die exzellente Lichtqualität setzt jeden Raum optimal in Szene.

**E** PUNTEO®-Y provides strong lighting effects. The high-performance spotlight with special hybrid crystal lenses has been developed to highlight individual object areas or interiors or to illuminate them using a light deflection system. The excellent light quality makes the most of every room.

**F** Le PUNTEO®-Y génère une note puissante. Doté d'une lentille spécifique en cristal hybride, ce spot ultra puissant a été développé pour mettre en valeur des intérieurs ou des objets immobiliers par une focalisation directe ou une technologie de redirection de la lumière. L'excellente qualité de luminosité met chaque pièce en scène de manière optimale.

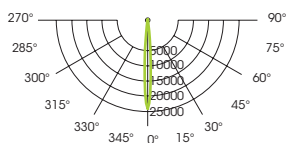

Photo: Thomas Krauss

# PUNTEO®-Y255 HYBRID



2x10°



2x20°

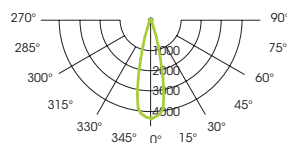

**D** PUNTEO®-Y255 HYBRID ist ein eng fokussierender LED-Strahler. Die hochwertigen Kristallglaslinsen ermöglichen eine erstklassige, blendfreie Lichtqualität, sowie eine lange Lebensdauer. Das äußerst stabile und langlebige Lichtsystem mit rein passiver Kühlung wurde eigens für anspruchsvolle Anwendungen im Außenbereich bei hohen Umgebungstemperaturen entwickelt. Mit einem Wirkungsgrad von >94% ist der lichtstarke PUNTEO®-Y255 HYBRID ebenso für den Einsatz in Verkaufs- oder Verkehrsbauten sowie in hocheffizienten Spiegel-Werfer-Systemen geeignet.





**E** PUNTEO®-Y255 HYBRID is a tight-focusing LED spotlight. The top-quality crystal glass lenses emit a first-class, glare-free light and have a long service life. The high stable and long-lasting light system with fully passive cooling has been developed for demanding applications in exterior and with high ambient temperatures. At an efficiency of more than 94%, the intense PUNTEO®-Y255 HYBRID can be used in commercial and traffic structures as well as in high efficient projector / reflector systems.

**F** Le PUNTEO®-Y255 HYBRID est un spot à LED ultra-puissant très focalisé. Les lentilles haut de gamme en verre cristal garantissent une lumière non éblouissante de grande qualité et une très grande longévité. Le système de lumière à la stabilité et à la longévité extrêmes avec refroidissement entièrement passif a été développé spécifiquement pour des applications exigeantes en extérieur et dans des températures environnantes importantes. Avec son rendement supérieur à 94%, le puissant PUNTEO®-Y255 HYBRID est le système d'éclairage parfait pour les infrastructures routières et commerciales, mais aussi pour les systèmes de miroirs projecteurs ultra-efficaces.

# PUNTEO®-Y255 HYBRID

## Finish

- Aluminium matt

-  700mA CC
-  Efficiency luminaire - 93lm/W
-  DALI
-  Driver external
-  2x10° / 2x20°
-  Wieland plug-in system  
RST 20i5

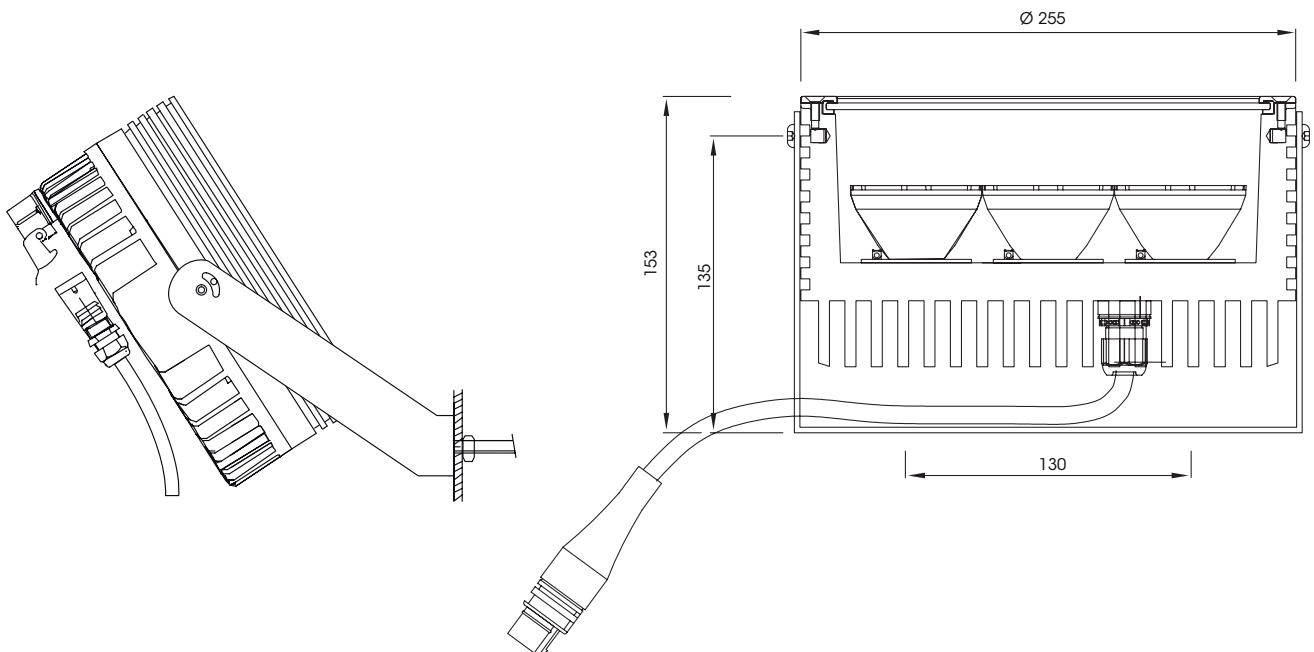
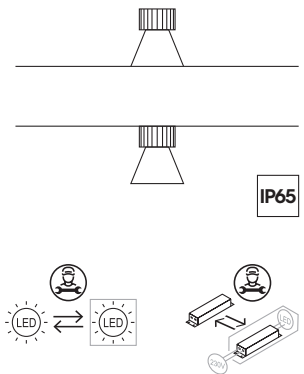

**Not dimmable:** on request

**LED**  
7x8W, 4000K, 5600lm

## Driver

**DALI**  
700mA / 75W · 241x60x307 mm  
N°: LVG 000-075-02-01  
In driver box

Other drivers on request

## LED LUMINAIRE

D= 255mm  
2x10° · 56W · 4000K    N°: PUNY255-054S4-01  
2x20° · 56W · 4000K    N°: PUNY255-054N4-01

# PUNTEO®-Y300 HYBRID



2x10°

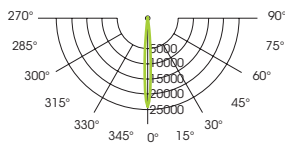

2x20°

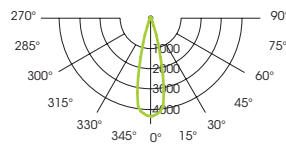

**D** PUNTEO®-Y300 HYBRID ist ein eng fokussierender Hochleistungs-LED Strahler. Die hochwertigen Kristallglaslinsen ermöglichen eine erstklassige, blendfreie Lichtqualität. Das äußerst stabile und langlebige Lichtsystem mit rein passiver Kühlung wurde eigens für anspruchsvolle Anwendungen im Außenbereich bei hohen Umgebungstemperaturen entwickelt. Mit einem Wirkungsgrad von >94% ist der lichtstarke PUNTEO®-Y300 HYBRID ebenso für den Einsatz in Verkaufs- oder Verkehrsbauten sowie in hocheffizienten Spiegel-Werfer-Systemen geeignet.







**E** PUNTEO®-Y300 HYBRID is a tight-focusing high-power LED spotlight. The top-quality crystal glass lenses emit a first-class, glare-free light. The high stable and long-lasting light system with fully passive cooling has been developed for demanding applications in exterior and with high ambient temperatures. At an efficiency of more than 94%, the intense PUNTEO®-Y300 HYBRID can be used in commercial and traffic structure as well as in high efficient projector/reflector systems.

**F** Le PUNTEO®-Y300 HYBRID est un spot à LED ultra-puissant très focalisé. Les lentilles haut de gamme en verre cristal garantissent une lumière non éblouissante de grande qualité. Le système de lumière à la stabilité et à la longévité extrêmes avec refroidissement entièrement passif a été développé spécifiquement pour des applications exigeantes en extérieur et dans des températures environnantes importantes. Avec son rendement supérieur à 94%, le puissant PUNTEO®-Y300 HYBRID est le système d'éclairage parfait pour les infrastructures routières et commerciales, mais aussi pour les systèmes de miroirs projecteurs ultra-efficents.

# PUNTEO®-Y300 HYBRID

## Finish

- Aluminium matt

-  700mA CC
-  Efficiency luminaire - 74lm/W
-  DALI
-  Driver external
-  2x10° / 2x20°
-  Wieland plug-in system  
RST 20i5

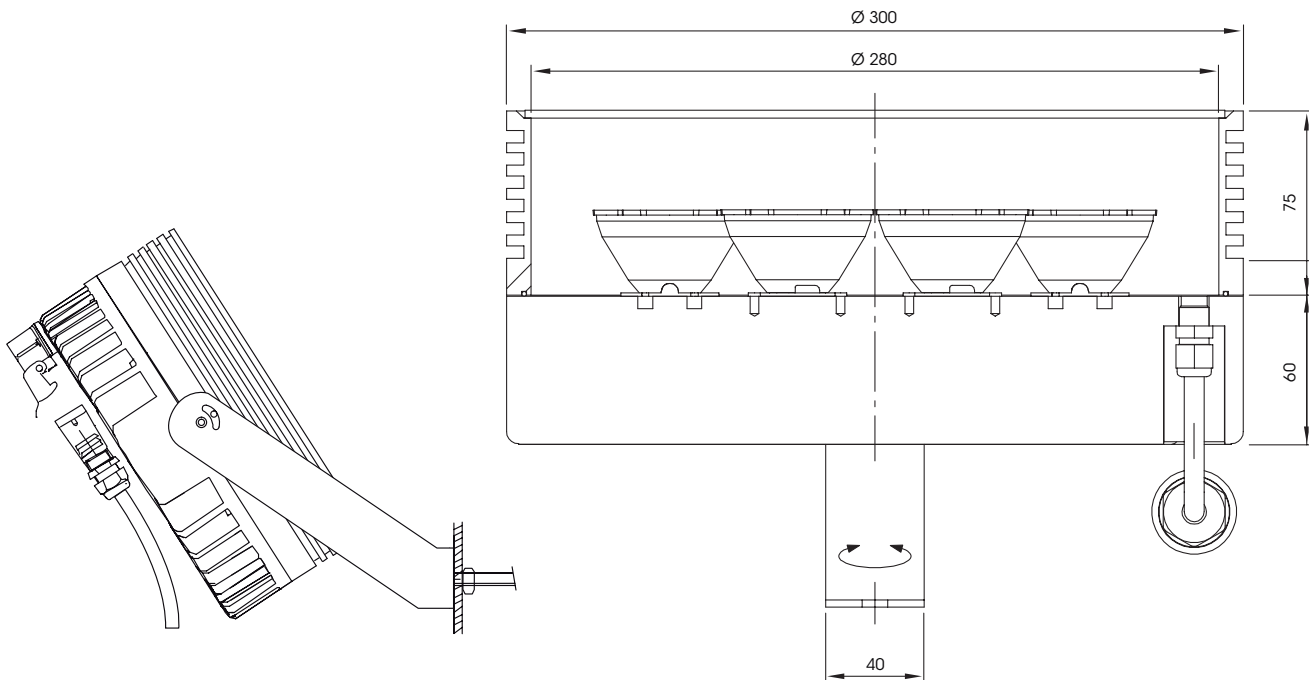
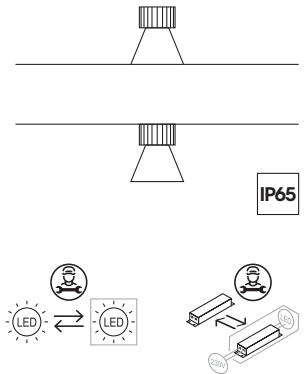

**Not dimmable:** on request

### LED

14x8W, 4000K, 9256lm

## Driver

### DALI

700mA / 150W · 241x43x30mm  
N°: LVG 000-150-02-02  
In driver box

Other drivers on request

## LED LUMINAIRE

D= 300mm

2x10° · 112W · 4000K

N°: PUNY300-112S4-01

2x20° · 112W · 4000K

N°: PUNY300-112N4-01







Educational institute of the  
trade association, Augsburg [D]  
Photo: Julia Schambeck





Restaurant George, Zurich [CH]  
Photo: Restaurant George





vanhout.pro office, Turnhout [BE]  
Photo: Liesbet Goetschalckx





Vienna University of Economics  
and Business, Vienna [AT]  
Photo: BOAnet.at







Roche Diagnostics [Switzerland] AG,  
Rotkreuz [CH]  
Photo: Rainer Keser

**D** Neben richtiger Beleuchtung sind Funktionalitäten wie optimale Akustik oder Klimatisierung heute selbstverständliche Bestandteile moderner Architektur. Das Raumempfinden spielt eine maßgebende Rolle in Bezug auf die Nutzung desselben.

Mit unseren Produkten möchten wir Funktionen und Anforderungen optimal und geschmackvoll in Räume integrieren und bestmögliche Ergebnisse erzielen.

**E** Besides correct illumination, functionalities such as optimum acoustics or air-conditioning are today taken for granted as components of modern architecture. The room feeling plays an important role in room usage.

With our products, we want to integrate functions and requirements optimally and tastefully into rooms and achieve optimum results.

**F** Outre un parfait éclairage, les fonctionnalités telles que l'acoustique ou la climatisation optimale sont d'importants composants dans l'architecture moderne. L'atmosphère dans le local joue un rôle déterminant pour son utilisation.

Avec nos produits, nous désirons intégrer la fonctionnalité et les exigences de manière optimale et avec goût dans les locaux afin d'obtenir le meilleur résultat possible.



Die beschriebene Leuchten-Effizienz ist das Verhältnis des ausgesendeten Lichtstroms der Leuchte zur benötigten elektrischen Energie. Leuchten-Treiber sind dabei nicht berücksichtigt, da verschiedene Treiberoptionen mit unterschiedlichen Eigeneffizienzen pro Leuchte möglich sind.

Alle mit einem \* angegebenen Werte sind Messwerte, bei denen leichte initiale Toleranzen auftreten können. So sind bei Leistung und Lichtstrom Toleranzen von +/-10% und bei der Farbtemperatur Toleranzen von +/-150K möglich.

Alle Maße in mm. Maß- und Konstruktionsänderungen bleiben uns vorbehalten. Aufgrund der rasanten Entwicklung im LED-Bereich sind Anpassungen, konstruktive oder technische Änderungen an unseren Produkten jederzeit möglich.

The described light efficiency is the relationship between the emitted luminous flux of the light and the required electric energy. The luminaire drivers are not taken into account since different driver options with different efficiencies per luminaire are possible.

All values marked with a \* are measured values which may have slight initial tolerances. The power and luminous flux may have a tolerance of +/-10% and the colour temperature a tolerance of +/-150K.

All measurements in mm. We reserve the right to make alternations in dimensions or design.

Owing to the fast pace of development in the LED sector, adaptations and constructional or technical modifications to our products are possible at any time.

L'efficacité énergétique des luminaires est le rapport entre la puissance du flux lumineux et l'énergie électrique consommée par les luminaires. Les pilotes de luminaires ne sont pas pris en compte, car les diverses options de pilotes peuvent afficher des différences au niveau de l'efficacité énergétique des luminaires.

Les valeurs marquées d'un \* sont des valeurs mesurées pouvant afficher une légère tolérance initiale. Ainsi, en matière de puissance et de flux lumineux, la tolérance est de +/-10%, tandis qu'elle est de +/-150K pour la température de couleur.

Toutes les dimensions sont données en mm. Sous réserve de changements des dimensions ou de la construction.

En raison des avancées rapides réalisées dans le domaine des LED des adaptations de nos produits relatives à la construction ou à la technique sont possibles à tout moment.

## Published by:

durlum GmbH  
An der Wiese 5  
79650 Schopfheim, Germany  
© 2022 durlum GmbH

Concept & Design: KRAUSSPROJECTS



Geschlossene Metalldecken | Closed metal ceilings | Plafonds métalliques fermés  
Offene Metalldecken | Open metal ceilings | Plafonds métalliques ouverts  
Funktionsdecken | Functional ceilings | Plafonds fonctionnels  
Deckensegel und Akustik | Raft ceilings and acoustics | Plafonds flottants et acoustique  
Designdecken | Design ceilings | Plafonds design



Objektbeleuchtung | Project lighting | Éclairage des objets  
Innen- und Außenleuchten | Interior and exterior lighting | Luminaires pour l'intérieur et l'extérieur  
Lichtmanagement | Lighting management | Gestion de lumière



Tageslichtrohre | Daylight tubes | Systèmes de lumière du jour  
Umlenkensysteme | Redirection systems | Luminaires à réflexion  
Abschattensysteme | Shading systems | Systèmes d'ombrage

# DECKE LICHT RAUM

CEILING LIGHTING AMBIENCE  
PLAFOND LUMIERE AMBIANCE

Kontakt vor Ort  
Local contact  
Contact local



[www.durlum.com/contact](http://www.durlum.com/contact)

**durlum GmbH** | An der Wiese 5 | D-79650 Schopfheim

T +49 (0) 76 22 | 39 05-0  
F +49 (0) 76 22 | 39 05-42  
E [info@durlum.com](mailto:info@durlum.com)  
I [www.durlum.com](http://www.durlum.com)