



CEILING
LIGHTING
AMBIENCE

S1 RHOMBOS

INSTALLATION MANUAL

GENERAL INFORMATION

GENERAL INFORMATION

This assembly manual addresses all metal ceilings manufactured by durlum. The different sections describe the corresponding products.

durlum is a leading German manufacturer of metal ceilings and cladding elements, mainly made of galvanised sheet steel, aluminium and expanded metal.



The relevant products are described in the marketing and sales documents. They are both acoustically effective, and can also be used as design elements only.

Specifically, these products are:

- Acoustic ceilings
- Chilled ceilings
- CHARACTER products

durlum differentiates between a wide range of ceiling systems, for example S1. "S" stands for the system, "1" for clamping. In this system, there are different nomenclatures that allow a further subdivision of the systems.

All durlum systems are systems of modular design. This applies not only to the substructure but also to the ceiling parts that are suspended, locked into place or placed on the substructure.

durlum metal ceilings comply with the standard EN 13964:2007 and are CE-certified.

For special systems marketed by us and for which no general approvals are available, there are suitable static certificates available, and suitable designs compliant with EN 13964 have been constructed.

GUIDELINES

These installation instructions have been structured in accordance with the requirement of EN 13964:2007. They describe a proper installation.

The description does not exempt the user from examining the structural conditions, implementing the building code regulations and observing the information given in the building permit prior to starting assembly. They have priority, but could not be included here.

It is advisable always to draw up assembly diagrams/drawings, to establish the location where assembly is to begin and to establish the required suspension points for the relevant ceiling system prior to starting assembly.

STRUCTURAL PRECONDITIONS

Metal ceilings may usually be installed as soon as the building is swept clean and at the latest after all wet work in the interior has been completed and the building has been closed.

Prior to starting assembly, the suspension points must be checked for their usability, and load introduction into the building must be guaranteed.

When using wall mounting points, such as brackets or wall anchors, the load-carrying capacity of the wall in question must be checked.

If ceiling elements rest on brackets, possible wall movements must be taken into account.

Only dowels for which a general building supervisory approval is available may be used, and their minimum extraction force must be greater than 100 kg. The dowels must be mounted as specified by the relevant dowel manufacturer. We recommend performing regular tensile stress tests, to verify that dowels have been set correctly.

durlum metal ceilings are dimensioned such that they carry their own weight of the system construction plus a surface load amounting to 40 N/m². Higher loads must be taken into account or suspended separately in the construction, and the measures must be adapted to the situation at hand. Usually, built-in components and loads must be suspended separately.

For ceiling systems that do not allow any tolerance compensation within a module, suitable material expansions must be taken into account.

Building expansion joints and tolerances customary in building construction must be taken into account accordingly.

durlum metal ceilings are, as a matter of principle, to be assembled by professional dry construction companies who are capable of assessing the overall conditions of the building, the metal ceiling and cladding, and can take the necessary precautions for correct, safe static mounting.

If parts from different manufacturers are used to assemble the ceiling, the relevant mounting company must provide the certificates required by EN 13964:2007 and must obtain suitable certificates of conformity itself.

Liability for proper selection of the products and system conformity can only be assumed for the systems delivered by durlum.

To prevent the parts from becoming dirty, gloves must be worn during assembly. If the ceiling products are delivered wrapped in a protective film, they must be protected from exposure to UV radiation [sunlight], the film must likewise have been removed from the goods no later than 4 weeks after delivery. The storage temperature must not exceed 30° C, since otherwise the adhesive on the panel may become hardened, and the protective film can no longer be removed.

STORAGE

durlum metal ceilings are usually delivered on pallets. It is advisable to leave the metal panels on the pallets as long as possible. If the pallets have to be opened, the durlum metal panel should always be positioned on the long side, it can then be placed carefully against the wall, do not store flat.

Storage must be carried out such that damage is excluded. During storage, durlum ceiling panels have to be protected from all weather influences. They have to be stored at a constant temperature between 10°C and 40°C.

The assembly of the ceiling panels must not start until all dust-producing work has been completed [swept clean].

durlum products are certified according to ISO 9001 for development, production, sales and also for service. Nonetheless, it is recommended as a matter of principle to inspect the delivered metal ceilings immediately and to report complaints immediately [as a rule immediately after delivery or within 3 days].

GENERAL INFORMATION

STANDARDS AND REGULATIONS

The relevant regulations applicable at the installation site must be determined by the assembly company in question. The ceilings marketed by durlum comply with EN 13964. This standard also regulates the classification of fire protection.

APPLICATION

The application of durlum metal ceilings is restricted, unless agreed upon otherwise, to interiors, so that, pursuant to EN 13964, class of use 1, corrosion protection class A, has been defined here as standard.

Should it become necessary to adjust the metal ceiling panels to the building by cutting them, we recommend protecting the cutting edges from corrosion by means of paint in order to maintain the corrosion protection class A.

QUALITY STANDARD

For material properties, dimensions, tolerances, colour deviations, the TAIM Directives [Technischer Arbeitskreis Industrieller Metalldeckenhersteller e.V.] (Technical Association of Industrial Metal Ceiling Manufacturers) applies.

MOUNTING SEQUENCE

1. Create a ceiling layout plan or use the one from the architect.
2. Cross-check the ceiling layout plan against the on-site situation.
3. Prepare a bill of materials, including a suitable work plan and retrieval/order of the materials required.
4. Determine the required suspension points in accordance with the classes of use of EN 13964. The corresponding suspension distances for the different systems can be taken from the detailed descriptions of the individual ceiling systems.
5. Define which generally approved dowel is suitable.

Check the raw ceiling and the walls.

Mark the dowel mounting holes and drill them.

Mount the dowels as specified by the dowel manufacturer and carry out extraction tests using the device recommended by the dowel manufacturer, if necessary.

6. Follow the same procedure when mounting the perimeter trim, mounting interval approx. 400-625 mm, check transmission of force into wall.
7. Shorten the provided fastening elements, such as the M6/M8 threaded rod to the intended length or order the correct length and mount it on the raw ceiling.
8. As a rule, arrangement of the panels should be from the centre of the room to compensate and halve the tolerances of the room/panels. The precise arrangement must always be done on the basis of the ceiling layout plan.
9. As a rule, durlum metal ceilings are provided with cross grids [primary profile].
10. Use the layout plan to determine in which direction the cross-bracing profiles are laid, either in parallel to the façade [usually] or vertically to the façade. The cross-supporting profiles should be mounted using a wall anchor or anchor span to prevent shifting in the transverse direction.

The respective primary profiles are mounted at a right angle to the secondary profiles. To this end, the system-specific connecting elements are used, see system descriptions.

The position of the primary profiles is defined in the reflected ceiling plan.

11. The metal ceiling panels are often provided with a joint tape [9x3mm], to make for easier tolerance compensation.

Should a joint tape be used, the joints must also be re-aligned from time to time, since the joint tape also has tolerances.

However, owing to the high production precision, it is also possible to connect the panels without a joint tape by using butt joints or provide them with rubber spacer naps.

Always ensure that the joints are aligned.

12. If the panels are placed on a perimeter trim, we recommend our F-bracket as bracket or as stepped F-bracket. The ceiling panel is cut with an angle cutter [i.e. Treco shears] and adapted to the particular room dimensions.

When calculating the minimum support area [10 mm], the dimensions of possible wall movement should be taken into account.

13. Attachments or other loads are to be mounted separately. For logical reasons these parts are integrated during the mounting process.

14. After completion and pre-acceptance of the ceiling, the sequence of joints should be re-aligned. Soiled ceiling panels should be cleaned to give a perfect result for assembly.

S1 RHOMBOS INSTALLATION MANUAL

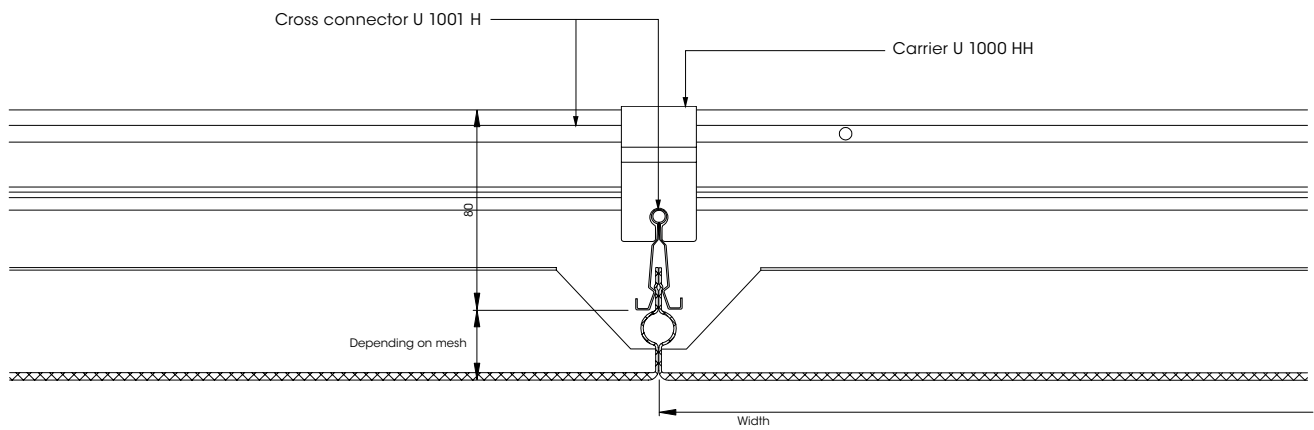
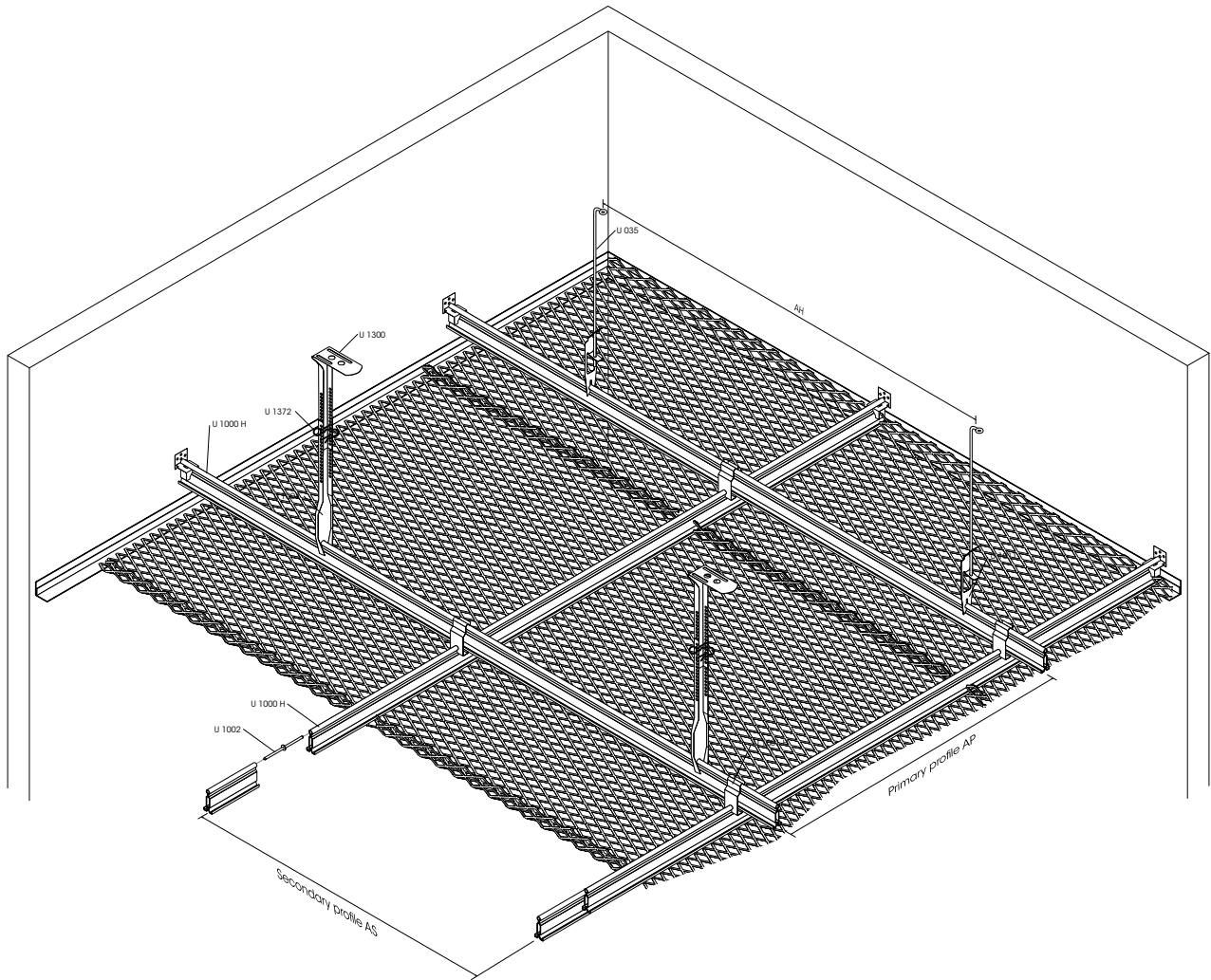

S1 RHOMBOS INSTALLATION MANUAL

ABBREVIATIONS

AP: Distance of primary profiles U 1000 H
AS: Distance of secondary profiles U 1000 H
AH: Distance of the suspension hangers in axial direction of the primary profile

DISTANCE OF THE SUSPENSIONS ETC.

Distance of the primary profiles AP according to EN 13964:

Class 1: <1 000mm
Class 2: <1 000mm

Distance of the secondary profiles AS according to EN 13964:

depending on the fastener width.

Distance of the suspension points AH:

The distance of the suspension points AH is determined by the corresponding panel length. The primary profile serves mainly for cross bracing.

The maximum force applied to the suspension point may be 200 N. The corresponding suspension parts and dowels must be taken into account.

If it is not possible to specify in advance where the secondary profiles will run, select the following distances of the suspension points AH:

Class 1: <1 000mm
Class 2: <1 200mm

Load-carrying capacity of the suspension points

[tensile loads]:

Maximum load per vernier suspension: 200 N
Maximum load per threaded rod M6: 500 N
Other loads must be verified statically.

Stress class according to EN 13964: Stress class A according to Table 7

PLEASE NOTE

- Use only officially approved dowels.
- The fastening base must be suitable in terms of statics. It must be able to reliably absorb the forces introduced into the construction.

ASSEMBLY OF THE SUSPENSION

Assembly of the wall bracket:

The regular distance for mounting the perimeter trim is max. 500 mm. This regular distance is less, depending on additional loads, the type of wall and special requirements.

1. Level and outline the given ceiling height.

2. Outline the upper edge of the perimeter trim.
3. Mark the drill hole.
4. Drill a hole for the dowel.
5. F-lip points upwards.
6. Secure the perimeter trim with a dowel.
7. Cleanly mitre cut the edges of the perimeter trim profiles.

Assembly of primary profile [U 1000 H]:

8. Outline the axis grid for the primary and secondary profiles.
9. Define the suspension points.
10. The suspension hangers of the primary profile should be mounted as close as possible to the crossing point of the primary and secondary profiles. The maximum distance between the suspension hanger and the secondary profile is 100 mm [also see "Distance of the suspension points AH"].
11. Cross connectors may not be mounted at the joint of the primary profiles.
12. Keep a distance of at least 400 mm to the joint of the primary profiles.
13. The maximum distance of a suspension point from the wall is 500 mm.
14. Drill a hole for the dowel.
15. Mount vernier scale upper part U 1300 or threaded rod M6 with dowels according to the manufacturer's instructions.
16. Cut the carrier U 1000 H to the required length and insert the vernier scale lower parts U 1004 or suspension hangers for threaded rod U 1011.
17. Secure vernier scale lower part U 1370 to vernier scale upper parts with two vernier scale safety pins U 1372. When using the threaded rod suspension, the threaded rod is guided through the horizontal shank of the suspension hanger U 1011 and rigidly fastened with the self-securing screw connection M6.
18. Place the carrier U 1000 H horizontally, vertically and aligned for the given ceiling height.
19. At the joint of the carriers, the carrier connector U 1002 A is inserted into the carrier.
20. Arrange the longitudinal carrier connections offset to one another.
21. When adjusting the height, observe the permissible height tolerances according to EN 13964, readjusting it, if necessary.
22. The primary profiles must be connected to the wall at least on one side with the wall bracket U 1010 to exclude any shift in axial direction.

Assembly of the secondary profile [U 1000 H]:

23. The cross connector U 1001 H is pushed onto the secondary profile and clipped into the primary profile. Then the distance of the secondary profile is adjusted. The secondary profiles must be

aligned exactly to the axial dimension of 600 mm or 625 mm to avoid distortions.

CEILING PANEL ASSEMBLY

1. Wear clean cotton gloves.
2. Remove the protective film from the ceiling panel, if available.
3. Snap ceiling panel into clip-in rail applying slight pressure to the longitudinal edge.
4. Slide mounting plate into the clip-in rail at the panel crossing point.
5. Snap ceiling panel into clip-in rail applying slight pressure to the longitudinal edge.
6. Pull out mounting plate by moving it carefully downwards.
7. Determine the length of the precut shim in the border area. Cut the precut shim to size using an angle cutter and deburr the cutting edge.
8. Slide precut shim into the carrier with one clip-in side and place it on the perimeter trim.

DISASSEMBLY OF THE METAL TILE

1. Wear clean cotton gloves.
2. Slide mounting plate into the clip-in rail at the panel crossing point.
3. Insert demounting hook into the expanded metal panel approx. 200mm [in the clamping cam area] from the panel edge.
4. Then remove the ceiling panel from the clip-in rail by slightly pulling it downwards.
5. Remove demounting hook and plate.

Note:

Owing to the small web thickness of the expanded metal, you have to pull as closely as possible to the clamping side and clamping cam. The force must be applied carefully, since otherwise the expanded metal may become deformed.

S1 RHOMBOS INSTALLATION MANUAL

ASSEMBLY OF THE EXPANDED METAL PANELS

The clamping cams and the stop bead are arranged on the long sides of the expanded metal ceiling panels. The long sides are flat rolled.

The tiles are force fitted into the suspension

via the clamping cams arranged on the long sides.

Due to the opposite meshes, a mounting plate serves as mounting aid. The mounting plate is slid into the clip-in rail on the long side at the panel crossing point. The ceiling panel is snapped into the clam-

ping rail by applying slight pressure in the direction of the clip-in rail [see assembly diagram].

The panels must be pressed uniformly into the clip-in rail. Do not press on the panel centre, since otherwise the surface may become deformed.

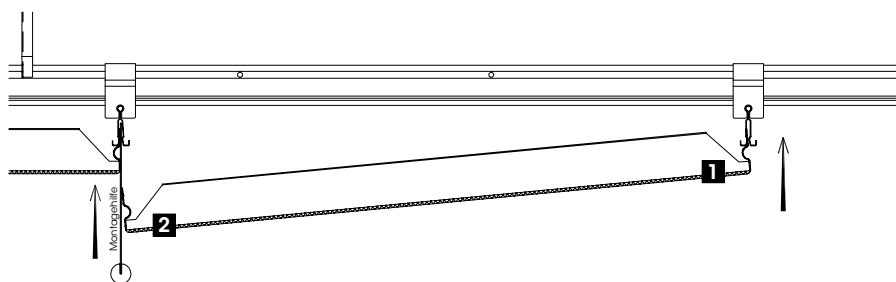

1 Snap ceiling panel into the clamping rail by applying slight pressure to the longitudinal edge.

2 Slide mounting plate into the clip-in rail at the panel crossing point.

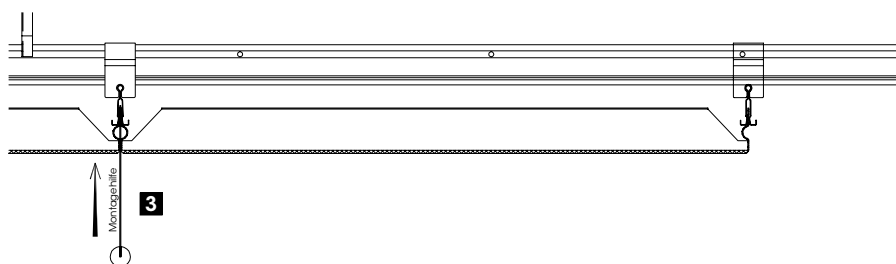

3 Snap ceiling panel into the clip-in rail by applying slight pressure to the longitudinal edge.

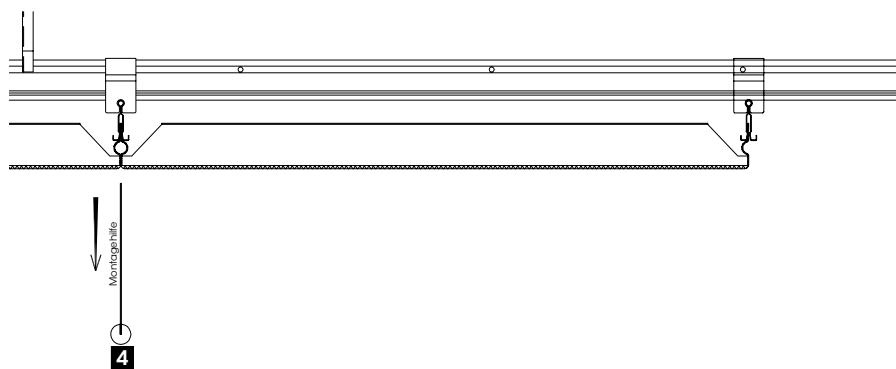

4 Pull out mounting plate by moving it carefully downwards.

S1 RHOMBOS INSTALLATION MANUAL

DISASSEMBLY OF THE EXPANDED METAL PANELS

For the disassembly of the ceiling panels, the enclosed mounting plate must be used. The mounting plate is slid into the clip-in rail at the panel crossing point. You must always pull by the edge, in order to avoid deformations of the ceiling panels.

The tiles can be pulled out of the clip-in system using a dismantling tool. You must proceed with particular care, since otherwise deformations may occur as a result of the material properties of the expanded metal.

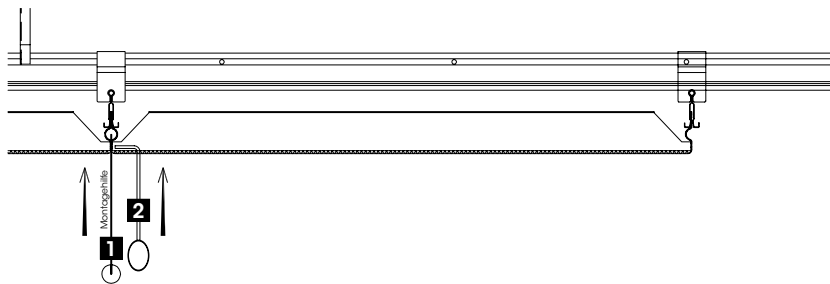

1 Slide mounting plate into the clip-in rail at the panel crossing point.

2 Insert demounting hook into the expanded metal panel approx. 200mm [in the clamping cam area] from the panel edge.

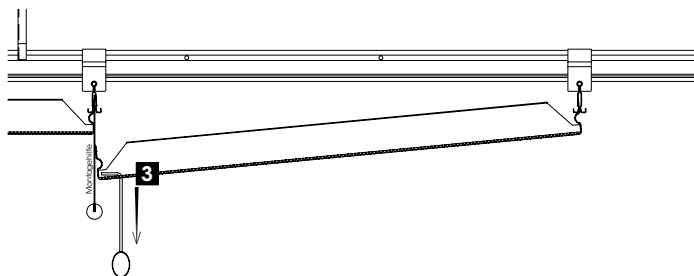

3 Then remove the ceiling panel from the clip-in rail by slightly pulling it downwards.

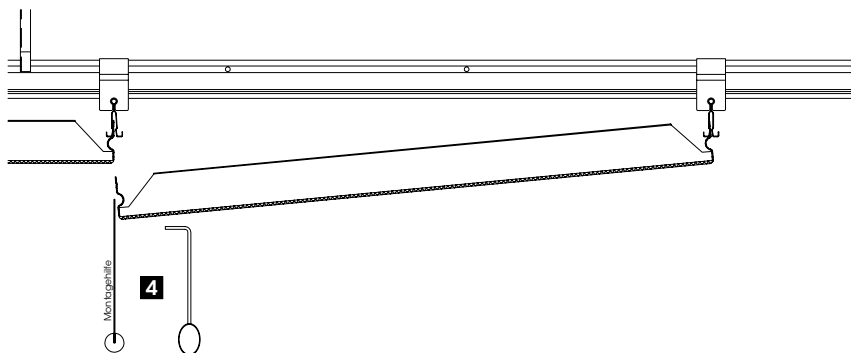

4 Remove demounting hook and plate.

S1 RHOMBOS INSTALLATION MANUAL

WALL BRACKET FOR ENTIRE EXPANDED METAL PANELS

Wall bracket profile - Perimeter trim F 025

[Alu]:

The wall bracket profiles are mounted to the on-site wall construction by means of officially approved dowels. The F-lip of the bracket is mounted pointing upwards.

The expanded metal panels are placed on the perimeter trim as whole panels.

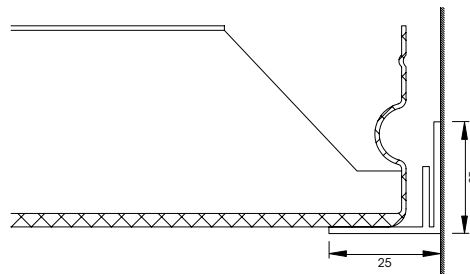

Wall bracket profile - Perimeter trim F 2025 [Alu]:

The wall bracket profiles are mounted to the on-site wall construction by means of officially approved dowels. The F-lip of the bracket is mounted pointing upwards.

The expanded metal panels are placed on the perimeter trim as whole panels.

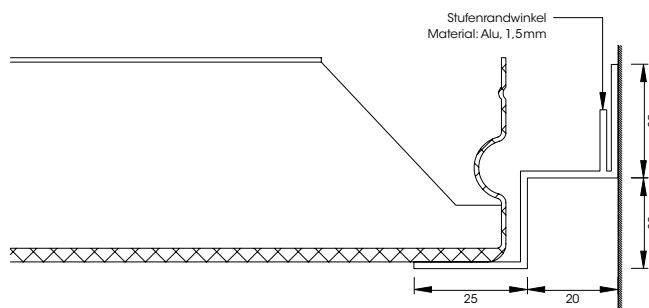

WALL BRACKET FOR CEILING PANELS CUT ON SITE

There are several possibilities of mounting the expanded metal panels cut on site by means of different wall brackets.

Wall bracket profile F 025 [special steel]:

The wall bracket profiles made of steel are mounted to the on-site wall construction by means of officially approved dowels. The expanded metal plates are cut on site and inserted into the F-lip.

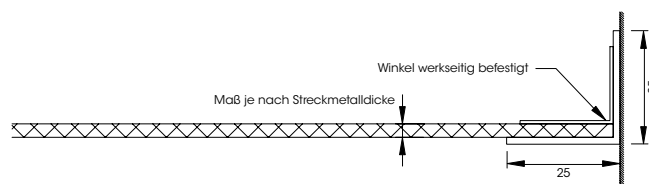

CEILING
LIGHTING
AMBIENCE

durlum GmbH | An der Wiese 5 | D-79650 Schopfheim

T +49 (0) 76 22 | 39 05-0
F +49 (0) 76 22 | 39 05-42
E info@durlum.com
I durlum.com